



**PRODUCT DATA & INSTALLATION**

Bulletin T30-TLPD-PDI-4  
Part # 1109293

**PRODUCT SUPPORT**  
 web: [www.t-rp.com/tlp](http://www.t-rp.com/tlp)  
 email: [evaps@t-rp.com](mailto:evaps@t-rp.com)  
 call: 1-844-893-3222 x520

scan:

# TLP New Generation "D" Low Profile Evaporator

**Air, Electric, & Hot Gas Defrost**

Electrical Power:  
115/1/60, 208-230/1/60, 208-230/3/60

**INCLUDES MODELS FOR DOE & NRCAN  
AWEF-COMPLIANT APPLICATIONS**

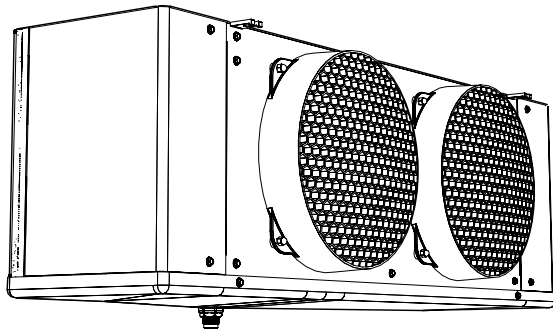

**SMARTSPEED™**  
FAN MOTOR TECHNOLOGY  
**STANDARD ON ALL MODELS**

**ESP+**  
 see page 15 for details

**INCLUDES RATINGS FOR  
LOW GWP  
REFRIGERANTS**

**CONTENTS**

	<b>Page</b>
Nomenclature.....	2
Features & Options.....	2
Selection Data.....	3 - 5
Electrical Data.....	6 - 11
Wiring Diagrams - Models with standard <b>SMARTSPEED™</b> motors .....	11 - 14
Wiring Diagrams - Models with <b>ESP+</b> .....	15 - 20
Annual Walk-In Energy Factor (AWEF) Ratings.....	21
Dimensional Data.....	22
Shipping Weights.....	23
Recommended Expansion Valve Selections.....	24
Expansion Valve Selections - Models with <b>ESP+</b> .....	25
Defrost Kit and Fuse Package Selections / Details .....	26 - 29
Installation Instructions.....	30 - 31
Hot Gas Piping Schematics.....	32 - 33
Project Information.....	34
Product Support Resources: Service Parts, Troubleshooting, Warranty, etc.....	35
"As Built" Service Parts List.....	BACK

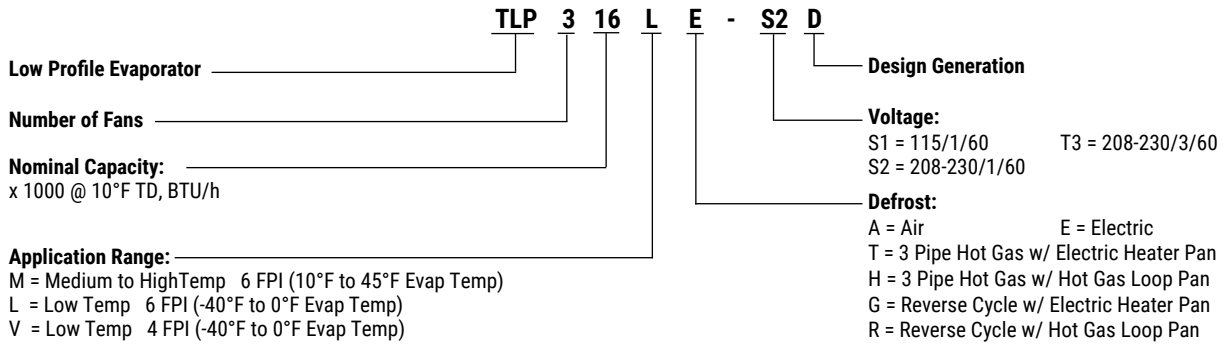

**STANDARD FEATURES**

- EC motors with patented SmartSpeed® Technology.
- Compatible with Low GWP Refrigerants
- High efficiency and high strength fan guard
- Front access
- Internally enhanced tubing
- Convenient mounting brackets
- Ample electrical and header compartments
- Liquid line solenoid valve wire harness factory installed
- Schrader valve on suction header
- Positive slope, hinged drain pan
- Central drain connections (approximate)
- Universal drain fitting
- Large 3/4" ID (3/4" MPT) drain hole
- Factory installed distributor nozzle

**AVAILABLE OPTIONS**

- ESP+ Intuitive Evaporator Control Technology.  
    See page 15
- Hot gas loop pan with hot gas defrost models
- Factory installed expansion valve, solenoid valve and room thermostat
- Wire fan guard
- Corrosion protection: alternate fin materials and coatings
- Additional options available, please contact factory

**R407A R407C R448A R449A**

**Medium Temperature - 6 FPI Models**

Model TLP	Qty. Fans	Evaporator Temperature Selection Capacity BTU/h			Air Flow		Refrig. Charge <b>R407A</b> **	
		20/25°F (-4/-7°C)	15°F (-9°C)	10°F (-12°C)	CFM	L/S	LB.	KG
104M	1	4310	4270	4220	750	350	0.7	0.3
106M		5910	5850	5790	705	330	1.1	0.5
107M		7000	6930	6860	680	320	1.5	0.7
209M	2	8700	8610	8530	1500	710	1.3	0.6
211M		11400	11300	11170	1410	670	1.4	0.6
214M		13700	13600	13430	1360	640	2.0	0.9
317M	3	16900	16700	16560	2115	1000	3.0	1.4
320M		20300	20100	19890	2040	960	4.0	1.8
422M	4	22400	22200	21950	2820	1330	3.3	1.5
427M		27000	26700	26460	2720	1280	3.9	1.8
534M		33700	33400	33030	3400	1600	6.5	2.9
640M	6	40400	40000	39590	4080	1930	7.8	3.5

- Capacities at other TD within a range of 8 to 15 °F (4.4 to 8.3°C) are directly proportional to TD, or use formula:

Capacity = Rated capacity ÷ 10 x TD.

\*\* For R448A/R449A, use conversion factor 0.96

**R404A R507**

**Medium Temperature - 6 FPI Models**

Model TLP	Qty. Fans	Evaporator Temperature Selection Capacity BTU/h			Air Flow		Refrig. Charge <b>R404A R507</b>	
		20/25°F (-4/-7°C)	15°F (-9°C)	10°F (-12°C)	CFM	L/S	LB.	KG
104M	1	4200	4160	4120	750	350	0.6	0.3
106M		5770	5710	5650	705	330	1.0	0.5
107M		6830	6760	6690	680	320	1.4	0.6
209M	2	8500	8420	8330	1500	710	1.2	0.5
211M		11100	10990	10880	1410	670	1.3	0.6
214M		13300	13200	13030	1360	640	1.8	0.8
317M	3	16600	16400	16270	2115	1000	2.8	1.3
320M		19800	19600	19400	2040	960	3.7	1.7
422M	4	21800	21600	21360	2820	1330	3.0	1.4
427M		26400	26100	25870	2720	1280	3.6	1.6
534M		32900	32600	32240	3400	1600	6.0	2.7
640M	6	39400	39000	38610	4080	1930	7.2	3.3

The above capacities were rated based on nominal 10°F TD

Capacities at other TD within a range of 8 to 15 °F (4.4 to 8.3°C) are directly proportional to TD, or use formula:

Capacity = Rated capacity ÷ 10 x TD.

**R407A R448A R449A**

**Low Temperature - 6 FPI Models**

Model TLP	Qty. Fans	Evaporator Temperature Selection Capacity BTU/h					Air Flow		Refrig. Charge <b>R407A</b> **	
		0°F (-18°C)	-10°F (-23°C)	-20°F (-29°C)	-30°F (-34°C)	-40°F (-40°C)	CFM	L/S	LB.	KG
104L	1	4310	4190	4070	3740	3460	750	350	0.7	0.3
105L		5190	5050	4900	4510	4170	705	330	1.1	0.5
106L		6710	6520	6330	5820	5380	680	320	1.5	0.7
207L	2	7590	7370	7160	6590	6090	1500	710	1.3	0.6
209L		9950	9670	9390	8640	7980	1410	670	1.4	0.6
211L		11980	11600	11300	10400	9610	1360	640	2.0	0.9
314L	3	14730	14300	13900	12800	11800	2115	1000	3.0	1.4
316L		17170	16700	16200	14900	13800	2040	960	4.0	1.8
418L	4	19500	19000	18400	16900	15600	2820	1330	3.3	1.5
421L		22470	21800	21200	19500	18000	2720	1280	3.9	1.8
526L	5	27670	26900	26100	24000	22200	3400	1600	6.5	2.9
631L	6	32970	32000	31100	28600	26400	4080	1930	7.8	3.5

- Capacities at other TD within a range of 8 to 15 °F (4.4 to 8.3°C) are directly proportional to TD, or use formula:

Capacity = Rated capacity ÷ 10 x TD.

\*\* For R448A/R449A, use conversion factor 0.96

**R404A R507**

**Low Temperature - 6 FPI Models**

Model TLP	Qty. Fans	Evaporator Temperature Selection Capacity BTU/h					Air Flow		Refrig. Charge <b>R404A</b> <b>R507</b>	
		0°F (-18°C)	-10°F (-23°C)	-20°F (-29°C)	-30°F (-34°C)	-40°F (-40°C)	CFM	L/S	LB.	KG
104L	1	4210	4090	3970	3650	3370	750	350	0.6	0.3
105L		5070	4920	4780	4400	4060	705	330	1.0	0.5
106L		6540	6360	6170	5680	5240	680	320	1.4	0.6
207L	2	7400	7190	6980	6420	5930	1500	710	1.2	0.5
209L		9710	9430	9160	8430	7790	1410	670	1.3	0.6
211L		11660	11330	11000	10120	9350	1360	640	1.8	0.8
314L	3	14420	14000	13600	12500	11560	2115	1000	2.8	1.3
316L		16750	16300	15800	14500	13430	2040	960	3.7	1.7
418L	4	18970	18400	17900	16500	15220	2820	1330	3.0	1.4
421L		21840	21200	20600	19000	17510	2720	1280	3.6	1.6
526L	5	27140	26400	25600	23600	21760	3400	1600	6.0	2.7
631L	6	32220	31300	30400	28000	25840	4080	1930	7.2	3.3

The above capacities were rated based on nominal 10°F TD

Capacities at other TD within a range of 8 to 15 °F (4.4 to 8.3°C) are directly proportional to TD, or use formula:

Capacity = Rated capacity ÷ 10 x TD.

**R407A R448A R449A**

**Low Temperature - 4 FPI Models**

Model TLP	Qty. Fans	Evaporator Temperature Selection Capacity BTU/h					Air Flow		Refrig. Charge R407A **	
		0°F (-18°C)	-10°F (-23°C)	-20°F (-29°C)	-30°F (-34°C)	-40°F (-40°C)	CFM	L/S	LB.	KG
103V	1	3880	3770	3660	3370	3110	750	350	0.7	0.3
104V		4610	4480	4350	4000	3700	705	330	1.1	0.5
106V		5880	5720	5550	5110	4720	680	320	1.5	0.7
207V	2	7070	6870	6670	6140	5670	1500	710	1.3	0.6
208V		8590	8340	8100	7450	6890	1410	670	1.4	0.6
211V		11200	10900	10600	9750	9010	1360	640	2.0	0.9
313V	3	13400	13000	12600	11600	10700	2115	1000	3.0	1.4
316V		16500	16100	15600	14400	13300	2040	960	4.0	1.8
418V	4	18800	18200	17700	16300	15000	2820	1330	3.3	1.5
421V		22300	21600	21000	19300	17900	2720	1280	3.9	1.8
524V	5	25300	24600	23900	22000	20300	3400	1600	6.5	2.9
627V	6	28400	27600	26800	24700	22800	4080	1930	7.8	3.5

- Capacities at other TD within a range of 8 to 15 °F (4.4 to 8.3°C) are directly proportional to TD, or use formula:  
Capacity = Rated capacity ÷ 10 x TD.

\*\* For R448A/R449A, use conversion factor 0.96

**R404A R507**

**Low Temperature - 4 FPI Models**

Model TLP	Qty. Fans	Evaporator Temperature Selection Capacity BTU/h					Air Flow		Refrig. Charge R404A R507	
		0°F (-18°C)	-10°F (-23°C)	-20°F (-29°C)	-30°F (-34°C)	-40°F (-40°C)	CFM	L/S	LB.	KG
103V	1	3640	3530	3430	3160	2920	750	350	0.6	0.3
104V		4300	4180	4060	3740	3450	705	330	1.0	0.5
106V		5500	5350	5190	4770	4410	680	320	1.4	0.6
207V	2	6600	6420	6230	5730	5300	1500	710	1.2	0.5
208V		8020	7800	7570	6960	6430	1410	670	1.3	0.6
211V		10460	10170	9870	9080	8390	1360	640	1.8	0.8
313V	3	12400	12100	11700	10760	9950	2115	1000	2.8	1.3
316V		15370	14900	14500	13300	12330	2040	960	3.7	1.7
418V	4	17600	17100	16600	15300	14110	2820	1330	3.0	1.4
421V		20880	20300	19700	18100	16750	2720	1280	3.6	1.6
524V	5	23640	23000	22300	20500	18960	3400	1600	6.0	2.7
627V	6	26610	25900	25100	23100	21340	4080	1930	7.2	3.3

The above capacities were rated based on nominal 10°F TD

Capacities at other TD within a range of 8 to 15 °F (4.4 to 8.3°C) are directly proportional to TD, or use formula:  
Capacity = Rated capacity ÷ 10 x TD.

## 115/1/60: Air Defrost &amp; Hot Gas Defrost with Hot Gas Loop Pan Models

Model TLP	FPI	FAN MOTORS						
		Qty.	Standard SMARTSPEED <sup>®</sup> EC Motors					
			HP	FLA Total	Watts	MCA (A)	Max. Fuse (AMPS)	
104MA-S1D *	6	1	1/15	1.0	60	1.3	15	
106MA-S1D *		1	1/15	1.0	60	1.3	15	
107MA-S1D *		1	1/15	1.0	60	1.3	15	
209M#-S1D		2	1/15	2.0	120	2.3	15	
211M#-S1D		2	1/15	2.0	120	2.3	15	
214M#-S1D		2	1/15	2.0	120	2.3	15	
317M#-S1D		3	1/15	3.0	180	3.3	15	
320M#-S1D		3	1/15	3.0	180	3.3	15	
422M#-S1D		4	1/15	4.0	240	4.3	15	
427M#-S1D		4	1/15	4.0	240	4.3	15	
534M#-S1D		5	1/15	5.0	300	5.3	15	
640M#-S1D		6	1/15	6.0	360	6.3	15	
104Lt-S1D		6	1	1/15	1.0	60	1.3	15
105Lt-S1D			1	1/15	1.0	60	1.3	15
106Lt-S1D	1		1/15	1.0	60	1.3	15	
207Lt-S1D	2		1/15	2.0	120	2.3	15	
209Lt-S1D	2		1/15	2.0	120	2.3	15	
211Lt-S1D	2		1/15	2.0	120	2.3	15	
314Lt-S1D	3		1/15	3.0	180	3.3	15	
316Lt-S1D	3		1/15	3.0	180	3.3	15	
418Lt-S1D	4		1/15	4.0	240	4.3	15	
421Lt-S1D	4		1/15	4.0	240	4.3	15	
526Lt-S1D	5		1/15	5.0	300	5.3	15	
631Lt-S1D	6		1/15	6.0	360	6.3	15	
103Vt-S1D	4		1	1/15	1.0	60	1.3	15
104Vt-S1D			1	1/15	1.0	60	1.3	15
106Vt-S1D		1	1/15	1.0	60	1.3	15	
207Vt-S1D		2	1/15	2.0	120	2.3	15	
208Vt-S1D		2	1/15	2.0	120	2.3	15	
211Vt-S1D		2	1/15	2.0	120	2.3	15	
313Vt-S1D		3	1/15	3.0	180	3.3	15	
316Vt-S1D		3	1/15	3.0	180	3.3	15	
418Vt-S1D		4	1/15	4.0	240	4.3	15	
421Vt-S1D		4	1/15	4.0	240	4.3	15	
524Vt-S1D		5	1/15	5.0	300	5.3	15	
627Vt-S1D		6	1/15	6.0	360	6.3	15	

# = A, H or R. Refer to nomenclature for details.

\* = H or R Available on 2 to 6 fan models only.

† = H or R Refer to nomenclature for details.

**208-230/1/60: Air Defrost & Hot Gas Defrost with Hot Gas Loop Pan Models**

Model TLP	FPI	FAN MOTORS					
		Qty.	Standard SMARTSPEED <sup>®</sup> EC Motors				
			HP	FLA Total	Watts	MCA (A)	Max. Fuse (AMPS)
104MA-S2D *	6	1	1/15	0.6	60	0.8	15
106MA-S2D *		1	1/15	0.6	60	0.8	15
107MA-S2D *		1	1/15	0.6	60	0.8	15
209M#-S2D		2	1/15	1.2	120	1.4	15
211M#-S2D		2	1/15	1.2	120	1.4	15
214M#-S2D		2	1/15	1.2	120	1.4	15
317M#-S2D		3	1/15	1.8	180	2.0	15
320M#-S2D		3	1/15	1.8	180	2.0	15
422M#-S2D		4	1/15	2.4	240	2.6	15
427M#-S2D		4	1/15	2.4	240	2.6	15
534M#-S2D		5	1/15	3.0	300	3.2	15
640M#-S2D		6	1/15	3.6	360	3.8	15
104Lt-S2D	6	1	1/15	0.6	60	0.8	15
105Lt-S2D		1	1/15	0.6	60	0.8	15
106Lt-S2D		1	1/15	0.6	60	0.8	15
207Lt-S2D		2	1/15	1.2	120	1.4	15
209Lt-S2D		2	1/15	1.2	120	1.4	15
211Lt-S2D		2	1/15	1.2	120	1.4	15
314Lt-S2D		3	1/15	1.8	180	2.0	15
316Lt-S2D		3	1/15	1.8	180	2.0	15
418Lt-S2D		4	1/15	2.4	240	2.6	15
421Lt-S2D		4	1/15	2.4	240	2.6	15
526Lt-S2D		5	1/15	3.0	300	3.2	15
631Lt-S2D		6	1/15	3.6	360	3.8	15
103Vt-S2D	4	1	1/15	0.6	60	0.8	15
104Vt-S2D		1	1/15	0.6	60	0.8	15
106Vt-S2D		1	1/15	0.6	60	0.8	15
207Vt-S2D		2	1/15	1.2	120	1.4	15
208Vt-S2D		2	1/15	1.2	120	1.4	15
211Vt-S2D		2	1/15	1.2	120	1.4	15
313Vt-S2D		3	1/15	1.8	180	2.0	15
316Vt-S2D		3	1/15	1.8	180	2.0	15
418Vt-S2D		4	1/15	2.4	240	2.6	15
421Vt-S2D		4	1/15	2.4	240	2.6	15
524Vt-S2D		5	1/15	3.0	300	3.2	15
627Vt-S2D		6	1/15	3.6	360	3.8	15

# = A, H or R. Refer to nomenclature for details.

\* = H or R Available on 2 to 6 fan models only.

† = H or R Refer to nomenclature for details.

208-230/1/60 & 208-230/3/60: Electric Defrost Models

Model TLP	FPI	FAN MOTORS						DEFROST HEATERS						
		Qty.	Standard SMARTSPEED <sup>®</sup> EC Motors					Total WATTS	208-230/1/60			208-230/3/60		
			HP	FLA Total	Watts	MCA (A)	Max. Fuse (AMPS)		Total AMPS	MCA (A)	Max. Fuse (AMPS)	Total AMPS	MCA (A)	Max. Fuse (AMPS)
104ME-*	6	1	1/15	0.6	60	0.8	15	1060	4.6	5.8	15	3.0	3.8	15
106ME-*		1	1/15	0.6	60	0.8	15	1060	4.6	5.8	15	3.0	3.8	15
107ME-*		1	1/15	0.6	60	0.8	15	1060	4.6	5.8	15	3.0	3.8	15
209ME-*		2	1/15	1.2	120	1.4	15	1890	8.2	10.3	15	5.3	6.7	15
211ME-*		2	1/15	1.2	120	1.4	15	1890	8.2	10.3	15	5.3	6.7	15
214ME-*		2	1/15	1.2	120	1.4	15	1890	8.2	10.3	15	5.3	6.7	15
317ME-*		3	1/15	1.8	180	2.0	15	2730	11.9	14.8	15	7.7	10.0	15
320ME-*		3	1/15	1.8	180	2.0	15	2730	11.9	14.8	15	7.7	10.0	15
422ME-*		4	1/15	2.4	240	2.6	15	3560	15.5	19.3	20	10.0	12.0	15
427ME-*		4	1/15	2.4	240	2.6	15	3560	15.5	19.3	20	10.0	12.0	15
534ME-*		5	1/15	3.0	300	3.2	15	4400	19.1	23.9	25	12.0	15.0	20
640ME-*		6	1/15	3.6	360	3.8	15	5230	22.7	28.4	30	15.0	18.0	20
104LE-*	6	1	1/15	0.6	60	0.8	15	1060	4.6	5.8	15	3.0	3.8	15
105LE-*		1	1/15	0.6	60	0.8	15	1060	4.6	5.8	15	3.0	3.8	15
106LE-*		1	1/15	0.6	60	0.8	15	1060	4.6	5.8	15	3.0	3.8	15
207LE-*		2	1/15	1.2	120	1.4	15	1890	8.2	10.3	15	5.3	6.7	15
209LE-*		2	1/15	1.2	120	1.4	15	1890	8.2	10.3	15	5.3	6.7	15
211LE-*		2	1/15	1.2	120	1.4	15	1890	8.2	10.3	15	5.3	6.7	15
314LE-*		3	1/15	1.8	180	2.0	15	2730	11.9	14.8	15	7.7	10.0	15
316LE-*		3	1/15	1.8	180	2.0	15	2730	11.9	14.8	15	7.7	10.0	15
418LE-*		4	1/15	2.4	240	2.6	15	3560	15.5	19.3	20	10.0	12.0	15
421LE-*		4	1/15	2.4	240	2.6	15	3560	15.5	19.3	20	10.0	12.0	15
526LE-*		5	1/15	3.0	300	3.2	15	4400	19.1	23.9	25	12.0	15.0	20
631LE-*		6	1/15	3.6	360	3.8	15	5230	22.7	28.4	30	15.0	18.0	20
103VE-*	4	1	1/15	0.6	60	0.8	15	1060	4.6	5.8	15	3.0	3.8	15
104VE-*		1	1/15	0.6	60	0.8	15	1060	4.6	5.8	15	3.0	3.8	15
106VE-*		1	1/15	0.6	60	0.8	15	1060	4.6	5.8	15	3.0	3.8	15
207VE-*		2	1/15	1.2	120	1.4	15	1890	8.2	10.3	15	5.3	6.7	15
208VE-*		2	1/15	1.2	120	1.4	15	1890	8.2	10.3	15	5.3	6.7	15
211VE-*		2	1/15	1.2	120	1.4	15	1890	8.2	10.3	15	5.3	6.7	15
313VE-*		3	1/15	1.8	180	2.0	15	2730	11.9	14.8	15	7.7	10.0	15
316VE-*		3	1/15	1.8	180	2.0	15	2730	11.9	14.8	15	7.7	10.0	15
418VE-*		4	1/15	2.4	240	2.6	15	3560	15.5	19.3	20	10.0	12.0	15
421VE-*		4	1/15	2.4	240	2.6	15	3560	15.5	19.3	20	10.0	12.0	15
524VE-*		5	1/15	3.0	300	3.2	15	4400	19.1	23.9	25	12.0	15.0	20
627VE-*		6	1/15	3.6	360	3.8	15	5230	22.7	28.4	30	15.0	18.0	20

\* = S2 or T3. Refer to nomenclature for details.



115/1/60: Hot Gas Defrost with Drain Pan Heater Models

Model TLP	FPI	FAN MOTORS						DRAIN PAN HEATERS			
		Qty.	Standard SMARTSPEED EC Motors					Total WATTS	Total AMPS	MCA (A)	Max. Fuse (AMPS)
			HP	FLA Total	Watts	MCA (A)	Max. Fuse (AMPS)				
209M#-S1D	6	2	1/15	1.2	120	1.4	15	410	3.6	4.5	15
211M#-S1D		2	1/15	1.2	120	1.4	15	410	3.6	4.5	15
214M#-S1D		2	1/15	1.2	120	1.4	15	410	3.6	4.5	15
317M#-S1D		3	1/15	1.8	180	2.0	15	560	4.9	6.1	15
320M#-S1D		3	1/15	1.8	180	2.0	15	560	4.9	6.1	15
422M#-S1D		4	1/15	2.4	240	2.6	15	720	6.3	7.8	15
427M#-S1D		4	1/15	2.4	240	2.6	15	720	6.3	7.8	15
534M#-S1D		5	1/15	3.0	300	3.2	15	880	7.7	9.6	15
640M#-S1D		6	1/15	3.6	360	3.8	15	1030	9.0	11.2	15
207L#-S1D		6	2	1/15	1.2	120	1.4	15	410	3.6	4.5
209L#-S1D	2		1/15	1.2	120	1.4	15	410	3.6	4.5	15
211L#-S1D	2		1/15	1.2	120	1.4	15	410	3.6	4.5	15
314L#-S1D	3		1/15	1.8	180	2.0	15	560	4.9	6.1	15
316L#-S1D	3		1/15	1.8	180	2.0	15	560	4.9	6.1	15
418L#-S1D	4		1/15	2.4	240	2.6	15	720	6.3	7.8	15
421L#-S1D	4		1/15	2.4	240	2.6	15	720	6.3	7.8	15
526L#-S1D	5		1/15	3.0	300	3.2	15	880	7.7	9.6	15
631L#-S1D	6		1/15	3.6	360	3.8	15	1030	9.0	11.2	15
207V#-S1D	4		2	1/15	1.2	120	1.4	15	410	3.6	4.5
208V#-S1D		2	1/15	1.2	120	1.4	15	410	3.6	4.5	15
211V#-S1D		2	1/15	1.2	120	1.4	15	410	3.6	4.5	15
313V#-S1D		3	1/15	1.8	180	2.0	15	560	4.9	6.1	15
316V#-S1D		3	1/15	1.8	180	2.0	15	560	4.9	6.1	15
418V#-S1D		4	1/15	2.4	240	2.6	15	720	6.3	7.8	15
421V#-S1D		4	1/15	2.4	240	2.6	15	720	6.3	7.8	15
524V#-S1D		5	1/15	3.0	300	3.2	15	880	7.7	9.6	15
627V#-S1D		6	1/15	3.6	360	3.8	15	1030	9.0	11.2	15

# = T or G. Refer to nomenclature for details.

## 208-230/1/60: Hot Gas Defrost with Drain Pan Heater Models

Model TLP	FPI	FAN MOTORS						DRAIN PAN HEATERS			
		Qty.	Standard SMARTSPEED <sup>®</sup> EC Motors					Total WATTS	Total AMPS	MCA (A)	Max. Fuse (AMPS)
			HP	FLA Total	Watts	MCA (A)	Max. Fuse (AMPS)				
209M <sup>^</sup> -S2D	6	2	1/15	1.2	120	1.4	15	410	1.8	2.2	15
211M <sup>^</sup> -S2D		2	1/15	1.2	120	1.4	15	410	1.8	2.2	15
214M <sup>^</sup> -S2D		2	1/15	1.2	120	1.4	15	410	1.8	2.2	15
317M <sup>^</sup> -S2D		3	1/15	1.8	180	2.0	15	560	2.4	3.0	15
320M <sup>^</sup> -S2D		3	1/15	1.8	180	2.0	15	560	2.4	3.0	15
422M <sup>^</sup> -S2D		4	1/15	2.4	240	2.6	15	720	3.1	3.9	15
427M <sup>^</sup> -S2D		4	1/15	2.4	240	2.6	15	720	3.1	3.9	15
534M <sup>^</sup> -S2D		5	1/15	3.0	300	3.2	15	880	3.8	4.8	15
640M <sup>^</sup> -S2D		6	1/15	3.6	360	3.8	15	1030	4.0	5.0	15
207L <sup>^</sup> -S2D		6	2	1/15	1.2	120	1.4	15	410	1.8	2.2
209L <sup>^</sup> -S2D	2		1/15	1.2	120	1.4	15	410	1.8	2.2	15
211L <sup>^</sup> -S2D	2		1/15	1.2	120	1.4	15	410	1.8	2.2	15
314L <sup>^</sup> -S2D	3		1/15	1.8	180	2.0	15	560	2.4	3.0	15
316L <sup>^</sup> -S2D	3		1/15	1.8	180	2.0	15	560	2.4	3.0	15
418L <sup>^</sup> -S2D	4		1/15	2.4	240	2.6	15	720	3.1	3.9	15
421L <sup>^</sup> -S2D	4		1/15	2.4	240	2.6	15	720	3.1	3.9	15
526L <sup>^</sup> -S2D	5		1/15	3.0	300	3.2	15	880	3.8	4.8	15
631L <sup>^</sup> -S2D	6		1/15	3.6	360	3.8	15	1030	4.0	5.0	15
207V <sup>^</sup> -S2D	4		2	1/15	1.2	120	1.4	15	410	1.8	2.2
208V <sup>^</sup> -S2D		2	1/15	1.2	120	1.4	15	410	1.8	2.2	15
211V <sup>^</sup> -S2D		2	1/15	1.2	120	1.4	15	410	1.8	2.2	15
313V <sup>^</sup> -S2D		3	1/15	1.8	180	2.0	15	560	2.4	3.0	15
316V <sup>^</sup> -S2D		3	1/15	1.8	180	2.0	15	560	2.4	3.0	15
418V <sup>^</sup> -S2D		4	1/15	2.4	240	2.6	15	720	3.1	3.9	15
421V <sup>^</sup> -S2D		4	1/15	2.4	240	2.6	15	720	3.1	3.9	15
524V <sup>^</sup> -S2D		5	1/15	3.0	300	3.2	15	880	3.8	4.8	15
627V <sup>^</sup> -S2D		6	1/15	3.6	360	3.8	15	1030	4.0	5.0	15

# = T or G. Refer to nomenclature for details.

115/1/60, 208-230/1/60: Air Defrost Models

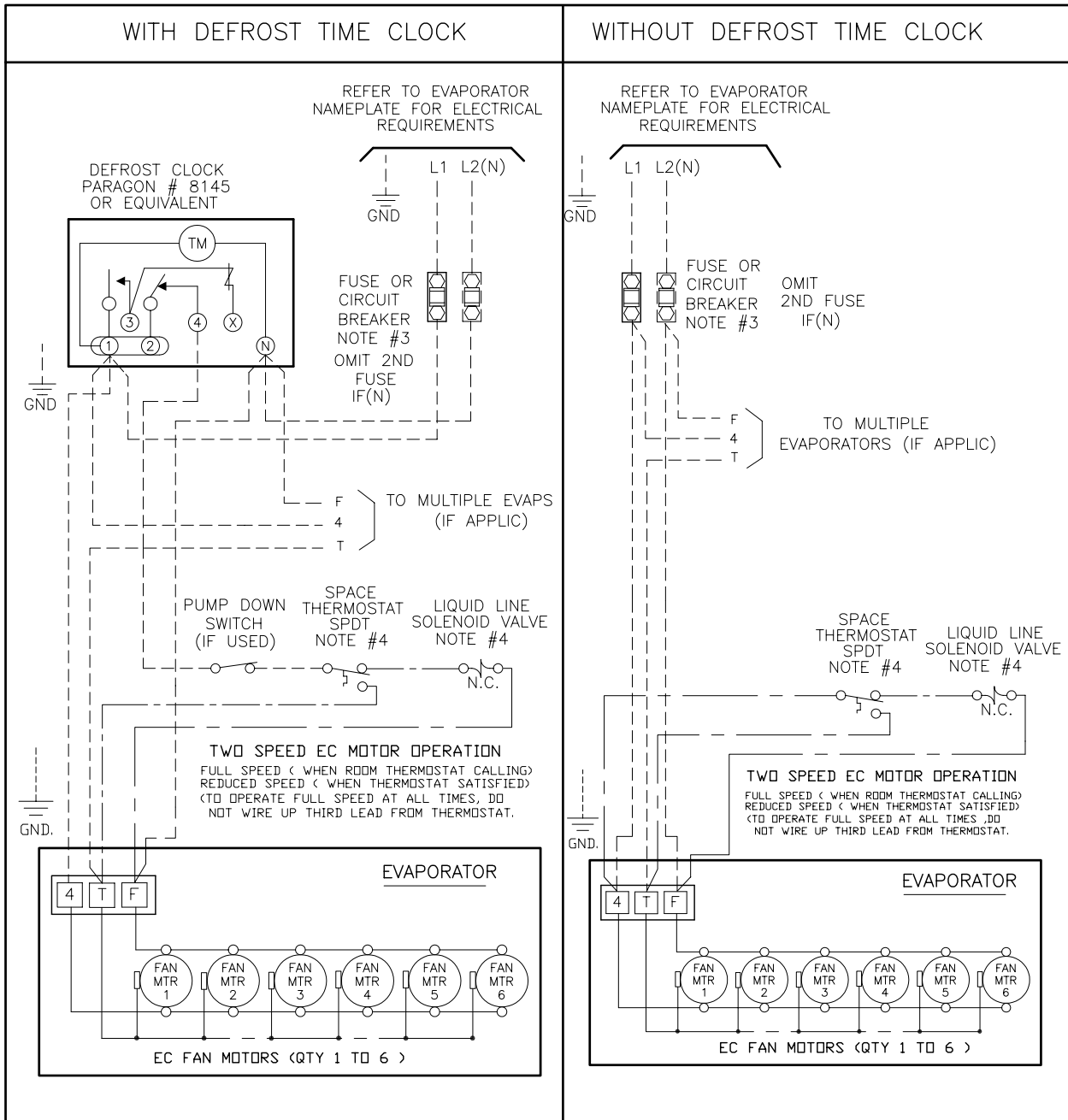

NOTES

- 1). USE COPPER CONDUCTORS ONLY
- 2). USE 75°C WIRE (OR HIGHER)
- 3). OVERCURRENT PROTECTION FOR EVAPORATOR FAN MOTORS AND DEFROST HEATERS MUST NOT EXCEED MAXIMUM VALUE SHOWN ON EVAPORATOR NAMEPLATE.
- 4). MAY BE FACTORY INSTALLED-MOUNTED AND WIRED ON EVAPORATOR. MUST BE SPDT TYPE IF TWO SPEED MODE IS REQUIRED.

1-LPEC AIR 01/10

TERMINALS

- -COMPONENT TERMINAL
- -TERMINAL BLOCK TERMINAL

CONDUCTORS/WIRING

- FACTORY WIRING
- - - - - WIRING BY OTHERS
- OPTIONAL FACTORY OR BY OTHERS

ALL FIELD WIRING MUST BE DONE IN COMPLIANCE WITH ALL APPLICABLE LOCAL AND NATIONAL CODES.

208-230/1/60: Electric Defrost Models

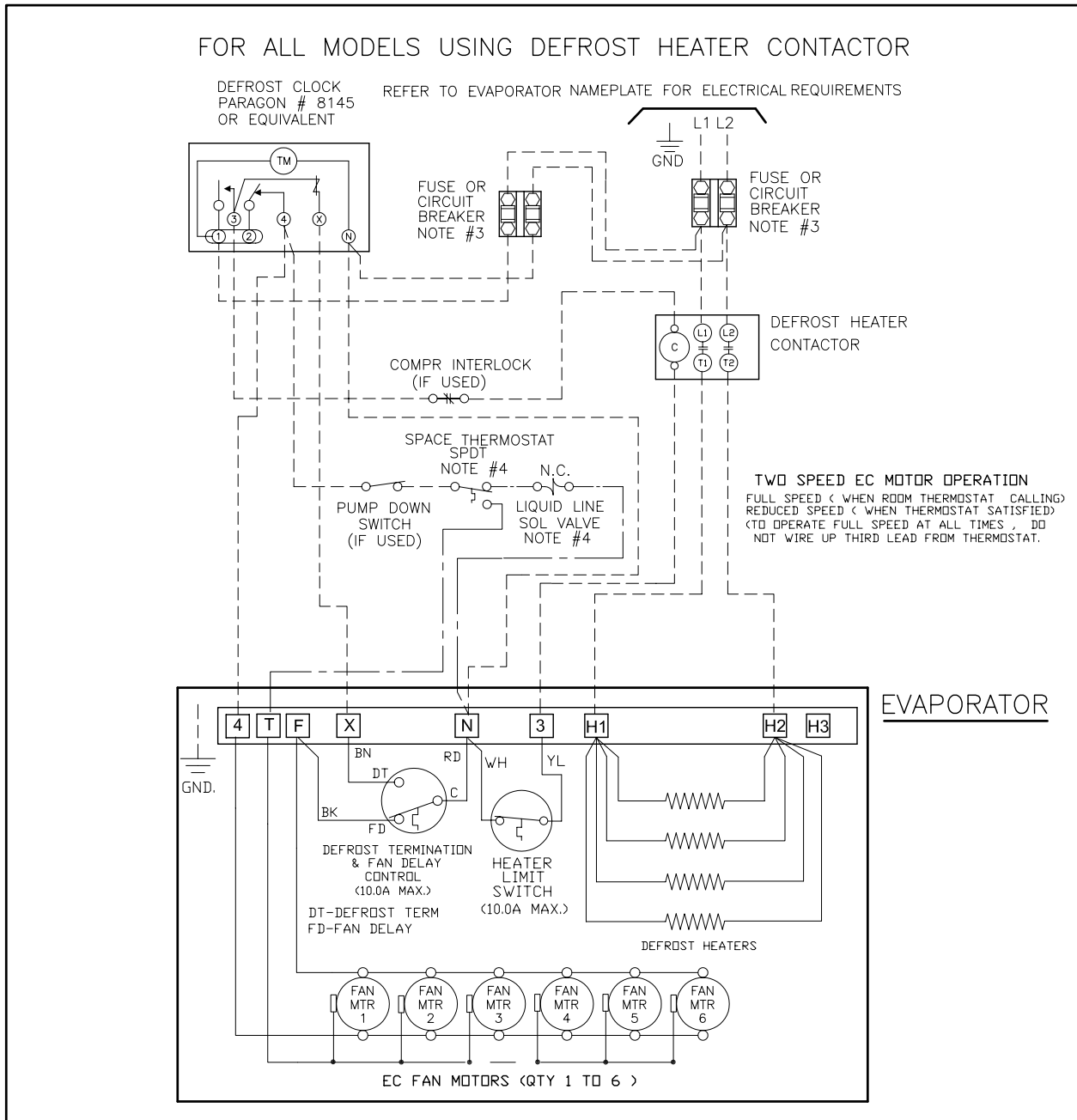

NOTES

- 1). USE COPPER CONDUCTORS ONLY
- 2). USE 75°C WIRE (OR HIGHER)
- 3). OVERCURRENT PROTECTION FOR EVAPORATOR FAN MOTORS AND DEFROST HEATERS MUST NOT EXCEED MAXIMUM VALUE SHOWN ON EVAPORATOR NAMEPLATE.
- 4). MAY BE FACTORY INSTALLED-MOUNTED AND WIRED ON EVAPORATOR . MUST BE SPDT TYPE IF TWO SPEED MODE IS REQUIRED.

TERMINALS

- -COMPONENT TERMINAL
- -TERMINAL BLOCK TERMINAL

CONDUCTORS/WIRING

- FACTORY WIRING
- WIRING BY OTHERS
- OPTIONAL FACTORY OR BY OTHERS

ALL FIELD WIRING MUST BE DONE IN COMPLIANCE WITH ALL APPLICABLE LOCAL AND NATIONAL CODES.

2-LPEC ED CONTACTOR SINGLE 01/10

208-230/1/60: Electric Defrost Models with Multiple Evaporators

FOR ALL MODELS USING DEFROST HEATER CONTACTOR

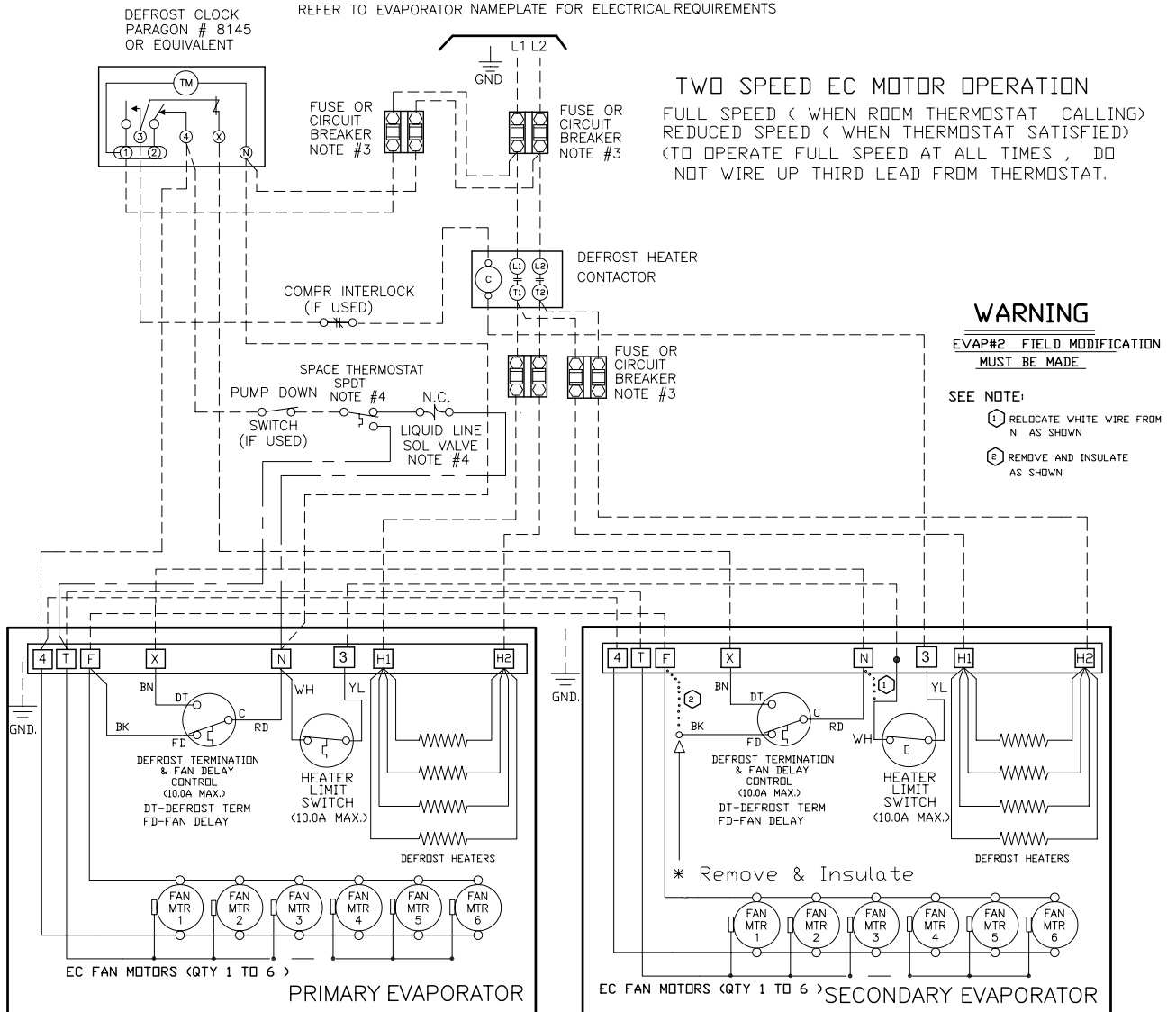

\* Fan delay not used on second evap / use fan contactor if total fan amps exceeds 10A

NOTES

- 1). USE COPPER CONDUCTORS ONLY
- 2). USE 75°C WIRE (OR HIGHER)
- 3). OVERCURRENT PROTECTION FOR EVAPORATOR FAN MOTORS AND DEFROST HEATERS MUST NOT EXCEED MAXIMUM VALUE SHOWN ON EVAPORATOR NAMEPLATE.
- 4). MAY BE FACTORY INSTALLED-MOUNTED AND WIRED ON EVAPORATOR. MUST BE SPDT TYPE IF TWO SPEED MODE IS REQUIRED.

3-LPEC ED CONTACTOR MULTI 01/10

TERMINALS

- -COMPONENT TERMINAL
- -TERMINAL BLOCK TERMINAL

CONDUCTORS/WIRING

- FACTORY WIRING
- WIRING BY OTHERS
- OPTIONAL FACTORY OR BY OTHERS

ALL FIELD WIRING MUST BE DONE IN COMPLIANCE WITH ALL APPLICABLE LOCAL AND NATIONAL CODES.

115/1/60, 208-230/1/60: Hot Gas Defrost Models

USING MAXIMUM 15A HEATER OVERCURRENT PROTECTION

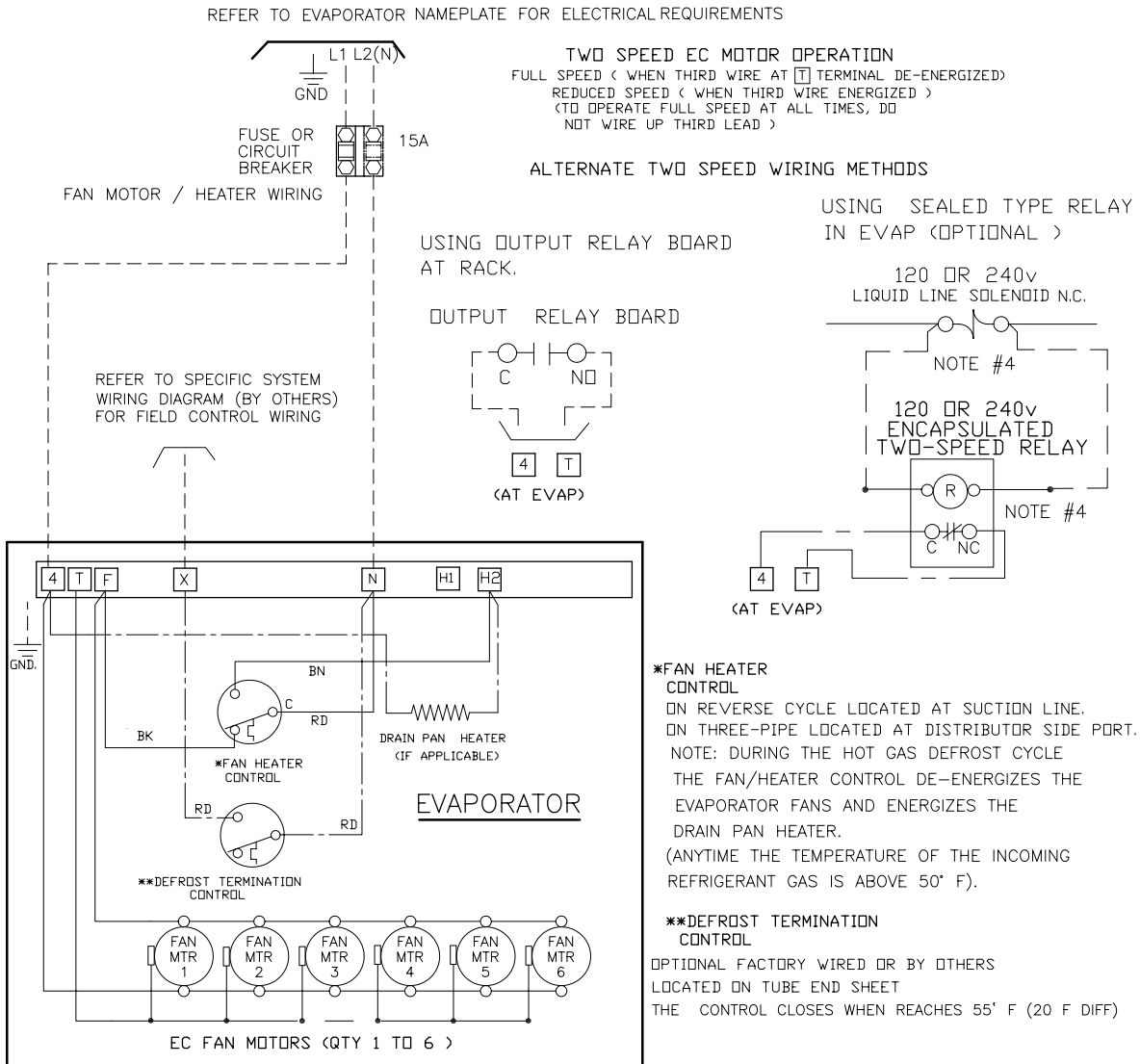

NOTES

- 1). USE COPPER CONDUCTORS ONLY
- 2). USE 75°C WIRE <OR HIGHER>
- 3). OVERCURRENT PROTECTION FOR EVAPORATOR FAN MOTORS AND DEFOST HEATERS MUST NOT EXCEED MAXIMUM VALUE SHOWN ON EVAPORATOR NAMEPLATE.
- 4). MAY BE FACTORY INSTALLED-MOUNTED AND WIRED ON EVAPORATOR .

TERMINALS

- -COMPONENT TERMINAL
- -TERMINAL BLOCK TERMINAL

CONDUCTORS/WIRING

- FACTORY WIRING
- WIRING BY OTHERS
- OPTIONAL FACTORY OR BY OTHERS

ALL FIELD WIRING MUST BE DONE IN COMPLIANCE WITH ALL APPLICABLE LOCAL AND NATIONAL CODES.

4-LPEC HG 01/10

## ESP+ INTUITIVE EVAPORATOR CONTROL TECHNOLOGY

### What is ESP+?

Trenton Refrigeration's ESP+ intuitive evaporator control technology is designed to replace traditional electro-mechanical refrigeration controls typically used on medium and low temperature applications. By combining award winning adaptive technology along with an electronic expansion valve, Trenton Refrigeration continues Leading The Way with innovative, state-of-the-art designs.

Installing an evaporator utilizing the ESP+ intuitive evaporator control technology is simple. Two pipes, two wires and you're done. No interconnecting control wiring between the evaporator and the condensing unit is required.

- Quick simple installation
- Improved evaporator performance by minimizing excessive frost on the evaporator
  - Eliminates ice build up on surfaces and product
  - Energy savings through evaporator fan management
  - Energy savings with reduction in the number of defrost cycles
    - Defrost heater management
- Improved system diagnostics and service through advanced alarm notification text/email
  - Remote monitoring & system control
    - User friendly interface
  - Precise temperature control for prolonged product shelf life
  - Improved product integrity with less potential for spoilage
  - Downloadable data provides system history for prior 30 days
  - Remotely view and change system parameters and alarm settings
    - Manually control system
    - Easily troubleshoot issues

### ESP+ controls:

- Box Temperature
- Superheat
- Liquid Line Solenoid
- Defrost Initiation
- Defrost Termination
- Fan Motors
- Defrost Heater (Electric Defrost Models)

Plus - User can access operating data directly from the system interface

## 15-20% System Energy Savings over a Properly Commissioned System!

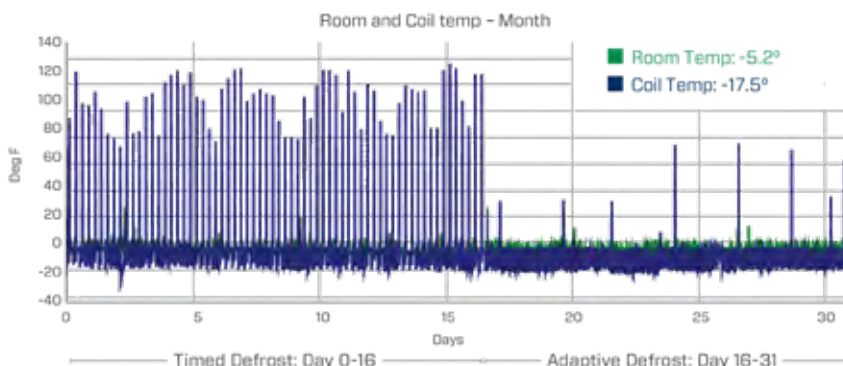

### 86% Fewer Defrost Cycles\*

- Enhanced system performance
- Energy Savings
- Improved product integrity

\* Data may vary depending on application

Visit [www.t-rp.com/esp](http://www.t-rp.com/esp) for details

115/1/60: Air Defrost Models with ESP

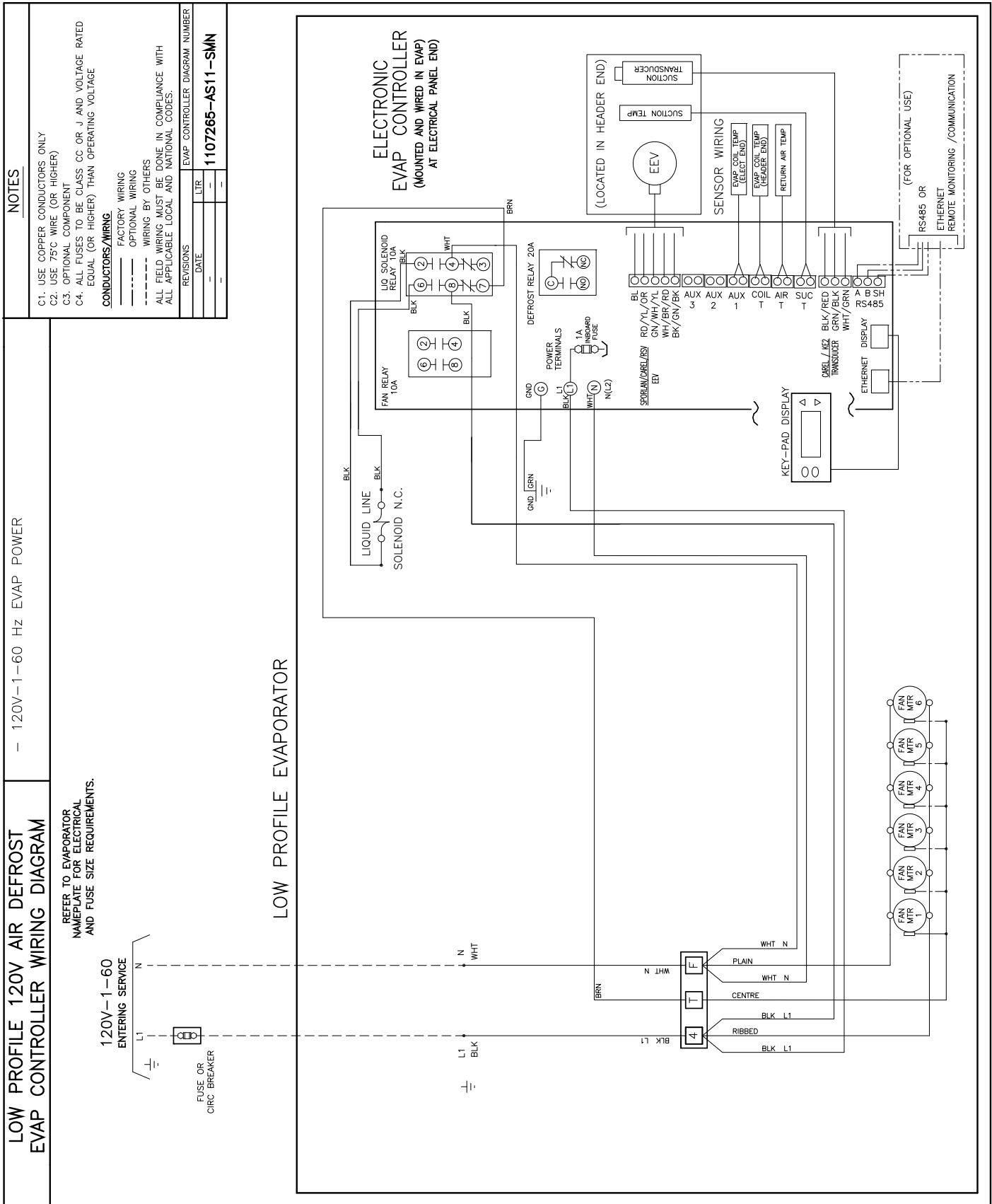



208-230/1/60: Air Defrost Models with ESP

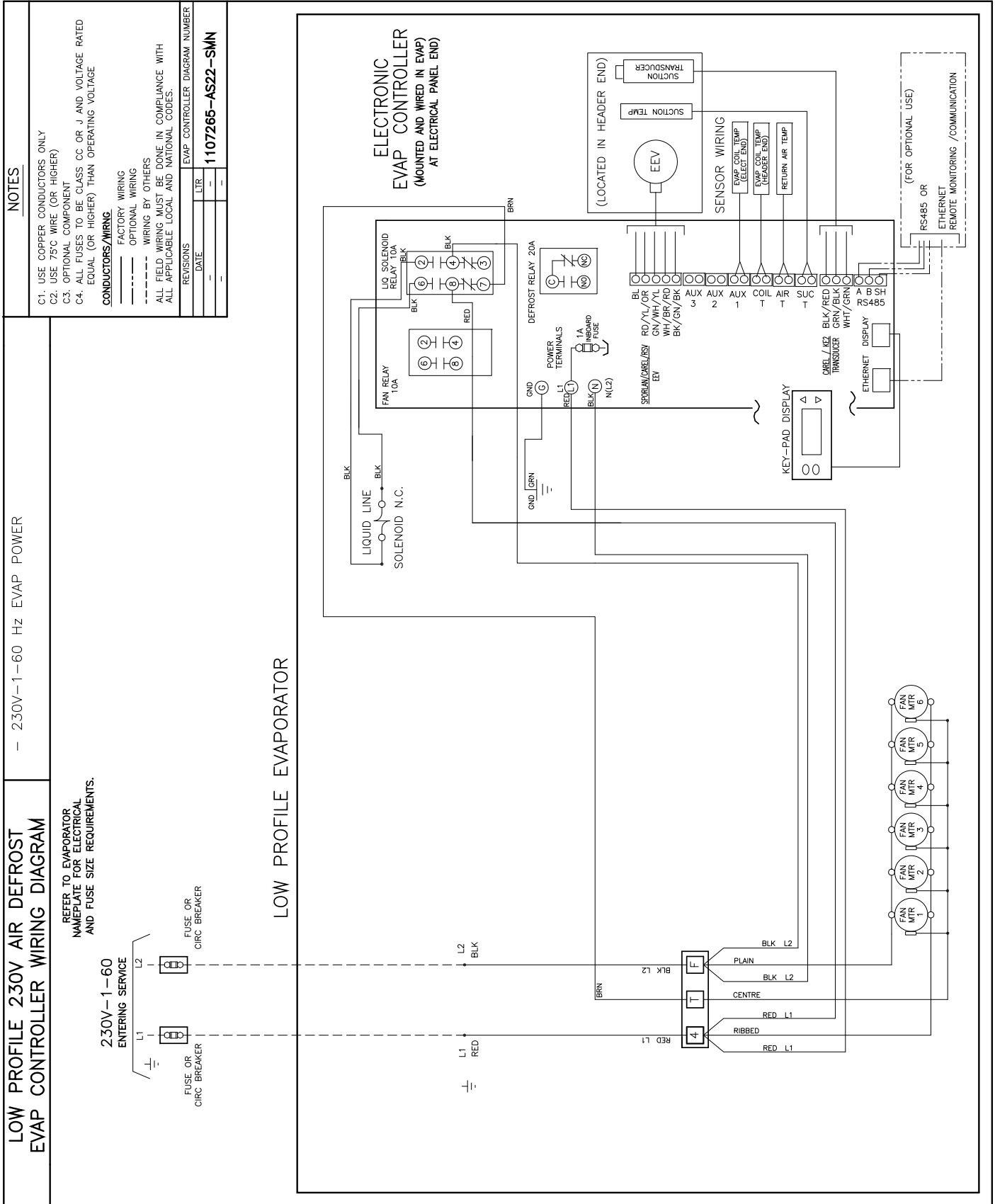

208-230/1/60: 1-3 Fan Electric Defrost Models with ESP Max.12A

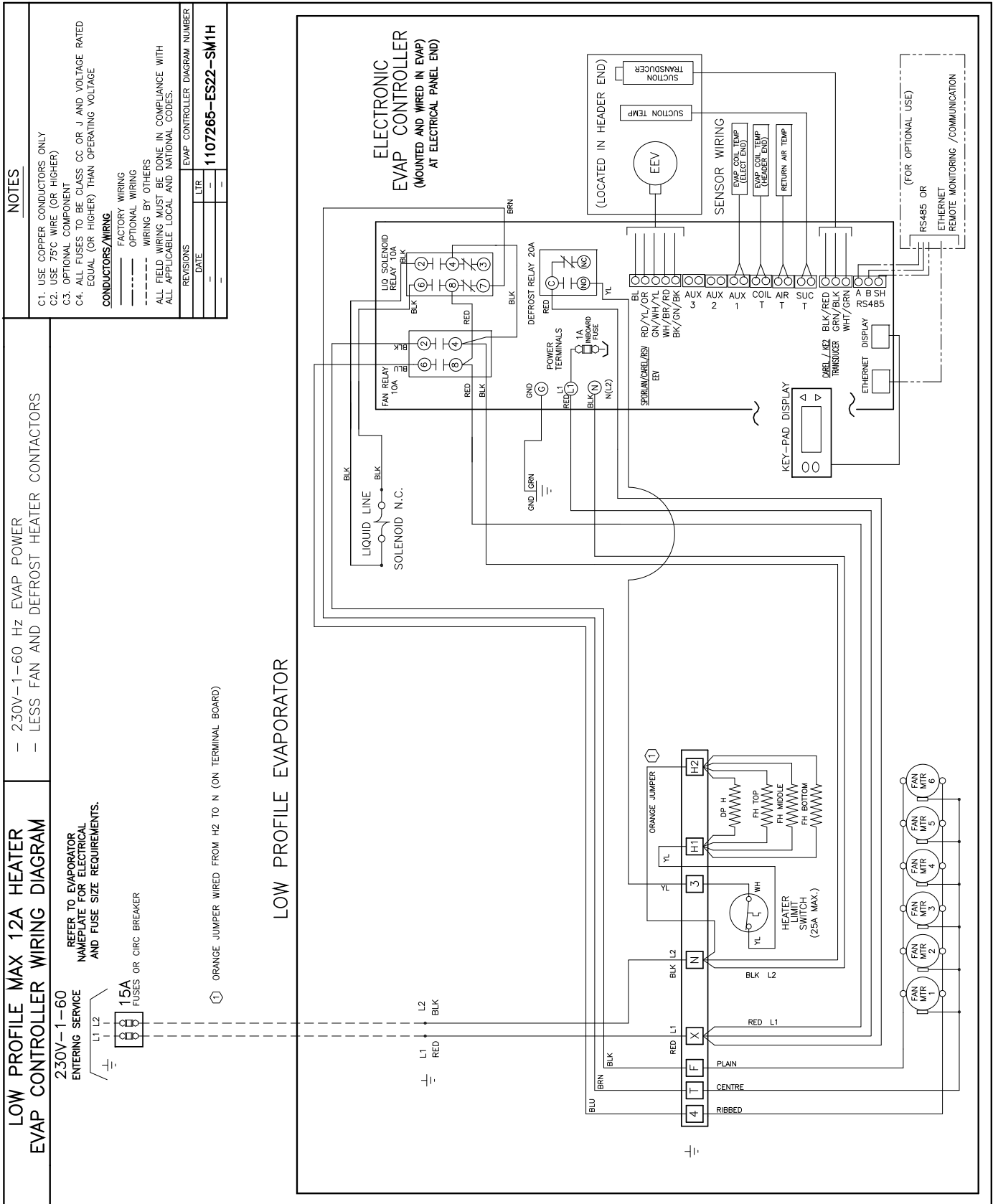

208-230/1/60: 4-5 Fan Electric Defrost Models with ESP 16A to 20A

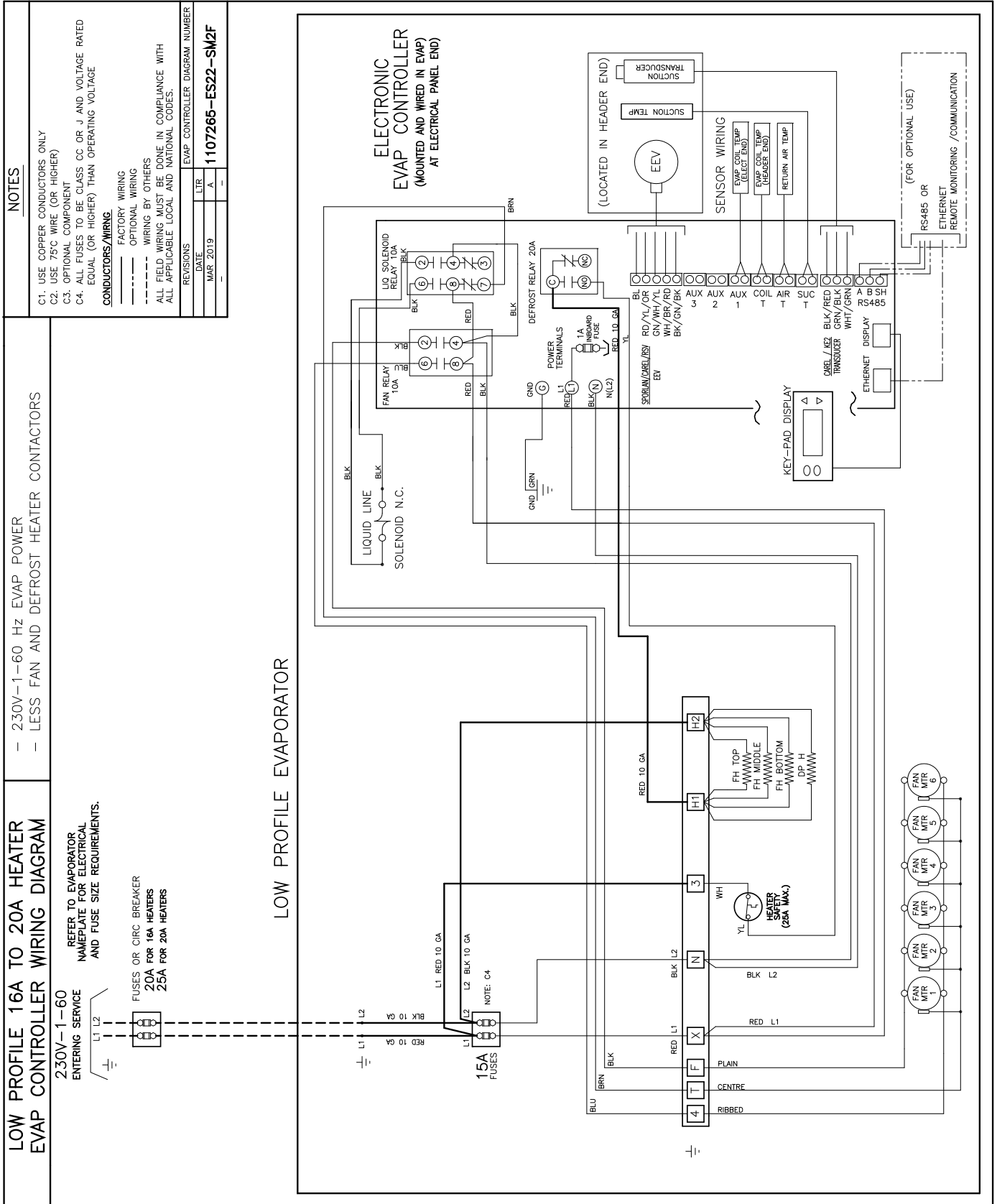

208-230/1/60: 6 Fan Electric Defrost Models with ESP 24A

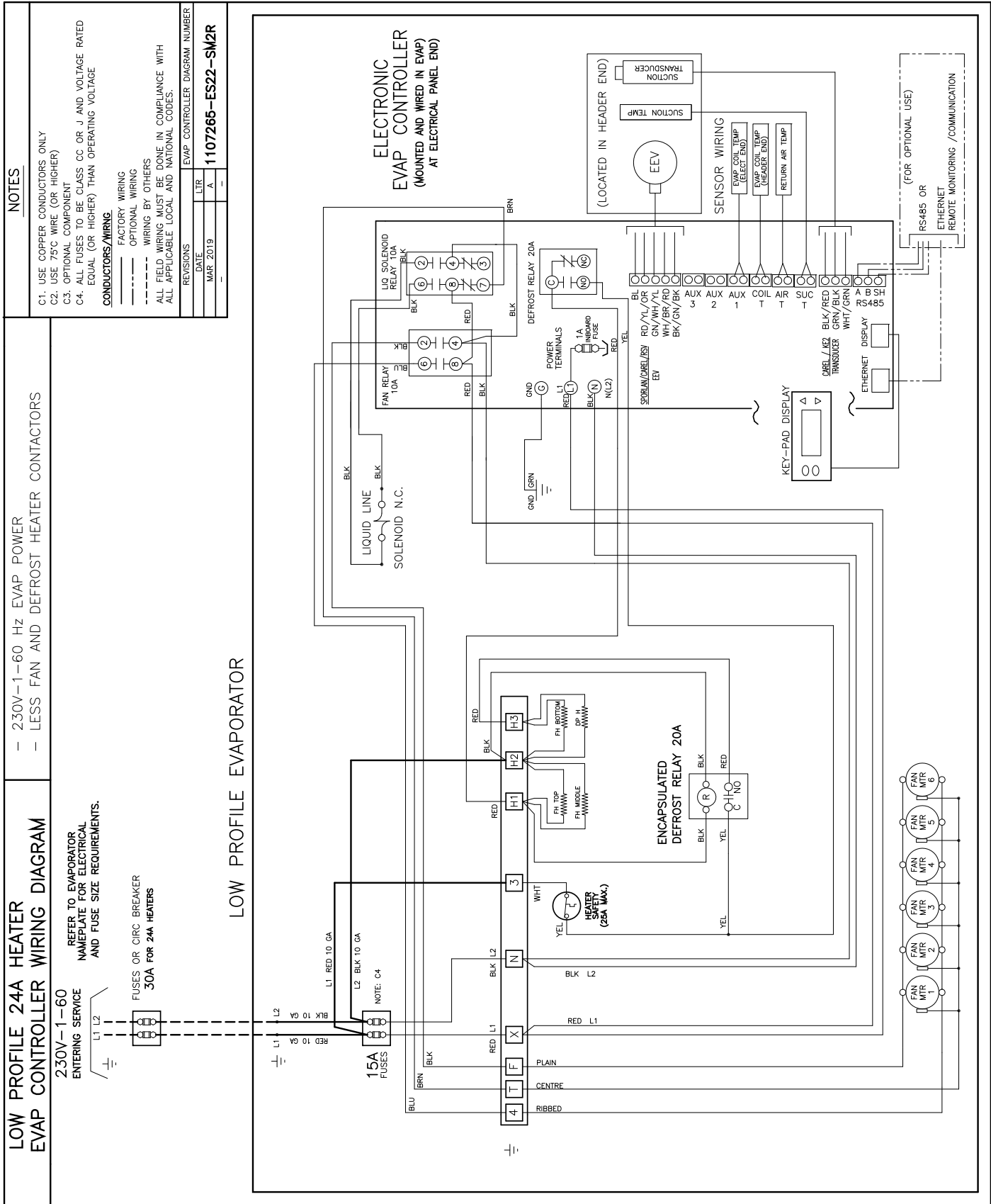

**Annual Walk-In Energy Factor Ratings - Medium Temperature**

If a numerical value is listed in the table below, the following statement applies to that corresponding model: " This refrigeration system is designed and certified for use in walk-in cooler applications."

Model TLP	<b>R404A</b> <b>R507</b>	<b>R407A</b> <b>R407C</b>	<b>R448A</b> <b>R449A</b>
104M	9.00	9.00	9.00
106M	9.00	9.00	9.00
107M	9.00	9.00	9.00
209M	9.00	9.00	9.00
211M	9.00	9.00	9.00
214M	9.00	9.00	9.00
317M	9.00	9.00	9.00
320M	9.00	9.00	9.00
422M	9.00	9.00	9.00
427M	9.00	9.00	9.00
534M	9.00	9.00	9.00
640M	9.00	9.00	9.00

**Annual Walk-In Energy Factor Ratings - Low Temperature**

If a numerical value is listed in the table below, the following statement applies to that corresponding model: " This refrigeration system is designed and certified for use in walk-in freezer applications."

Model TLP	<b>R404A</b> <b>R507</b>	<b>R407A</b>	<b>R448A</b> <b>R449A</b>
104L	3.96	3.96	3.96
105L	3.97	3.97	3.97
106L	3.99	3.99	3.99
207L	3.99	3.99	3.99
209L	4.02	4.02	4.02
211L	4.04	4.04	4.04
314L	4.07	4.07	4.07
316L	4.10	4.10	4.10
418L	4.13	4.13	4.13
421L	4.15	4.15	4.15
526L	4.15	4.15	4.15
631L	4.15	4.15	4.15

Model TLP	<b>R404A</b> <b>R507</b>	<b>R407A</b>	<b>R448A</b> <b>R449A</b>
103V	3.95	3.95	3.95
104V	3.96	3.96	3.96
106V	3.98	3.98	3.98
207V	3.99	3.99	3.99
208V	4.01	4.01	4.01
211V	4.04	4.04	4.04
313V	4.06	4.06	4.06
316V	4.10	4.10	4.10
418V	4.13	4.13	4.13
421V	4.15	4.15	4.15
524V	4.15	4.15	4.15
627V	4.15	4.15	4.15

# DIMENSIONAL DATA / SPECIFICATIONS

# TLP - LOW PROFILE EVAPORATORS

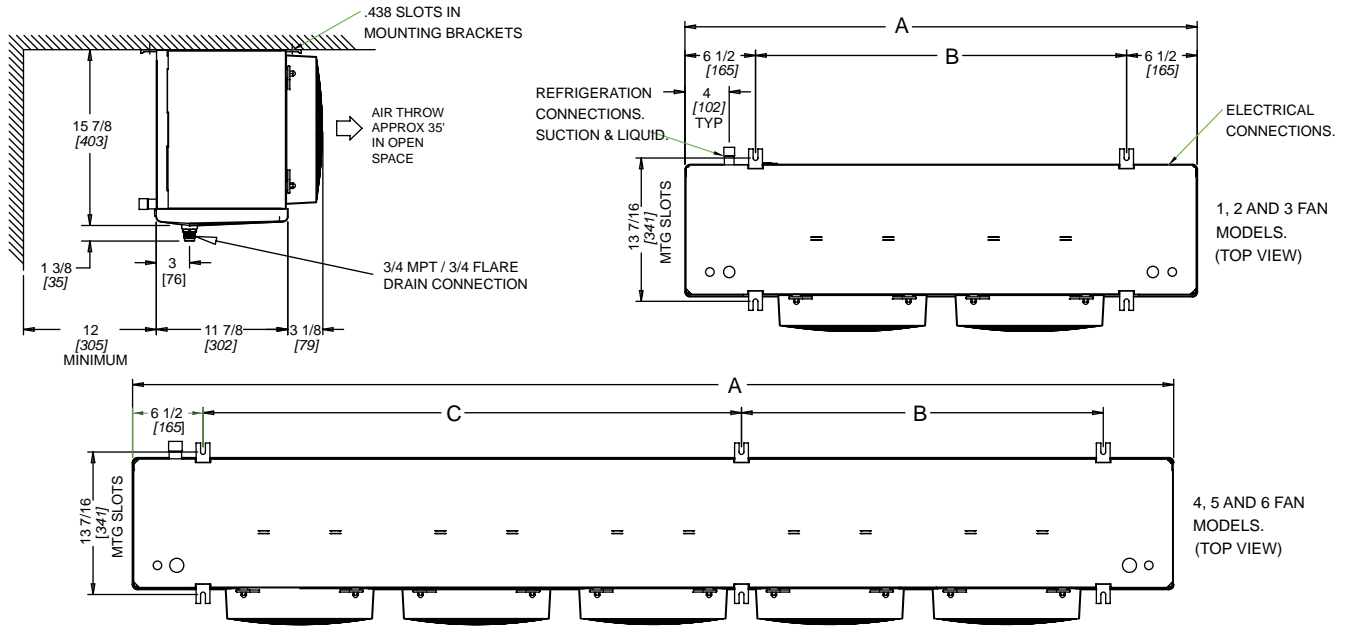

MODEL TLP	NO. OF FANS	A		B		C		SUCTION CONNECTION (ID) SWEAT	DISTRIBUTOR INLET SIZE	HOT GAS DIS- TRIBUTOR SIDE PORT	DRAIN PAN LOOP
		IN	mm	IN	mm	IN	mm				
104M <sup>^</sup>	1	30 1/4	768	17 1/4	438	N/A	N/A	5/8	1/2	1/2	N/A
106M <sup>^</sup>		30 1/4	768	17 1/4	438	N/A	N/A	5/8	1/2	1/2	N/A
107M <sup>^</sup>		30 1/4	768	17 1/4	438	N/A	N/A	5/8	1/2	1/2	N/A
209M#	2	46 1/4	1175	33 1/4	845	N/A	N/A	7/8	1/2	1/2	5/8
211M#		46 1/4	1175	33 1/4	845	N/A	N/A	7/8	1/2	1/2	5/8
214M#		46 1/4	1175	33 1/4	845	N/A	N/A	7/8	1/2	1/2	5/8
317M#	3	62 1/4	1581	49 1/4	1251	N/A	N/A	7/8	1/2	1/2	7/8
320M#		62 1/4	1581	49 1/4	1251	N/A	N/A	7/8	1/2	1/2	7/8
422M#	4	78 1/4	1988	32 5/8	829	32 5/8	829	1 1/8	1/2	1/2	7/8
427M#		78 1/4	1988	32 5/8	829	32 5/8	829	1 1/8	1/2	1/2	7/8
534M#	5	94 1/4	2394	32 5/8	829	48 5/8	1235	1 3/8	1/2	1/2	1 1/8
640M#	6	110 1/4	2800	48 5/8	1235	48 5/8	1235	1 3/8	7/8	5/8	1 1/8
104L <sup>^</sup>	1	30 1/4	768	17 1/4	438	N/A	N/A	5/8	1/2	1/2	N/A
105L <sup>^</sup>		30 1/4	768	17 1/4	438	N/A	N/A	5/8	1/2	1/2	N/A
106L <sup>^</sup>		30 1/4	768	17 1/4	438	N/A	N/A	5/8	1/2	1/2	N/A
207L#	2	46 1/4	1175	33 1/4	845	N/A	N/A	7/8	1/2	1/2	5/8
209L#		46 1/4	1175	33 1/4	845	N/A	N/A	7/8	1/2	1/2	5/8
211L#		46 1/4	1175	33 1/4	845	N/A	N/A	7/8	1/2	1/2	5/8
314L#	3	62 1/4	1581	49 1/4	1251	N/A	N/A	7/8	1/2	1/2	7/8
316L#		62 1/4	1581	49 1/4	1251	N/A	N/A	1 1/8	1/2	1/2	7/8
418L#	4	78 1/4	1988	32 5/8	829	32 5/8	829	1 1/8	1/2	1/2	7/8
421L#		78 1/4	1988	32 5/8	829	32 5/8	829	1 1/8	7/8	5/8	7/8
526L#	5	94 1/4	2394	32 5/8	829	48 5/8	1235	1 3/8	7/8	5/8	1 1/8
631L#	6	110 1/4	2800	48 5/8	1235	48 5/8	1235	1 3/8	7/8	5/8	1 1/8
103V <sup>^</sup>	1	30 1/4	768	17 1/4	438	N/A	N/A	5/8	1/2	1/2	N/A
104V <sup>^</sup>		30 1/4	768	17 1/4	438	N/A	N/A	5/8	1/2	1/2	N/A
106V <sup>^</sup>		30 1/4	768	17 1/4	438	N/A	N/A	5/8	1/2	1/2	N/A
207V#	2	46 1/4	1175	33 1/4	845	N/A	N/A	7/8	1/2	1/2	5/8
208V#		46 1/4	1175	33 1/4	845	N/A	N/A	7/8	1/2	1/2	5/8
211V#		46 1/4	1175	33 1/4	845	N/A	N/A	7/8	1/2	1/2	5/8
313V#	3	62 1/4	1581	49 1/4	1251	N/A	N/A	7/8	1/2	1/2	7/8
316V#		62 1/4	1581	49 1/4	1251	N/A	N/A	1 1/8	1/2	1/2	7/8
418V#	4	78 1/4	1988	32 5/8	829	32 5/8	829	1 1/8	1/2	1/2	7/8
421V#		78 1/4	1988	32 5/8	829	32 5/8	829	1 1/8	7/8	5/8	7/8
524V#	5	94 1/4	2394	32 5/8	829	48 5/8	1235	1 3/8	7/8	5/8	1 1/8
627V#	6	110 1/4	2800	48 5/8	1235	48 5/8	1235	1 3/8	7/8	5/8	1 1/8

# = A, E, T, H, G, or R. <sup>^</sup> = A or E. T, H, G or R available in 2 to 6 fan models only Refer to Nomenclature for details

**Air Defrost and Hot Gas Defrost with Drain Pan Heater Models**

MODEL NUMBER TLP							SHIPPING WEIGHT	
							LB.	(kg)
104MA	N/A	N/A	N/A	N/A	N/A	N/A	45	(20)
106MA							47	(21)
107MA							49	(22)
209MA	209MT	209MG	207LG	207LT	207VG	207VT	70	(32)
211MA	211MT	211MG	209LG	209LT	208VG	208VT	74	(33)
214MA	214MT	214MG	211LG	211LT	211VG	211VT	78	(35)
317MA	317MT	317MG	314LG	314LT	313VG	313VT	101	(46)
320MA	320MT	320MG	316LG	316LT	316VG	316VT	107	(48)
422MA	422MT	422MG	418LG	418LT	418VG	418VT	117	(53)
427MA	427MT	427MG	421LG	421LT	421VG	421VT	135	(61)
534MA	534MT	534MG	526LG	526LT	524VG	524VT	163	(74)
640MA	640MT	640MG	631LG	631LT	627VG	627VT	192	(87)

**Electric Defrost Models**

MODEL NUMBER TLP			SHIPPING WEIGHT	
			LB.	(kg)
104ME	104LE	103VE	49	(22)
106ME	105LE	104VE	51	(23)
107ME	106LE	106VE	53	(24)
209ME	207LE	207VE	76	(35)
211ME	209LE	208VE	80	(36)
214ME	211LE	211VE	84	(38)
317ME	314LE	313VE	109	(49)
320ME	316LE	316VE	115	(52)
422ME	418LE	418VE	127	(58)
427ME	421LE	421VE	145	(66)
534ME	526LE	524VE	176	(80)
640ME	631LE	627VE	207	(94)

**Hot Gas Defrost with Drain Pan Loop Models**

MODEL NUMBER TLP						SHIPPING WEIGHT	
						LB.	(kg)
209MH	209MR	207LH	207LR	207VH	207VR	87	(39)
211MH	211MR	209LH	209LR	208VH	208VR	91	(41)
214MH	214MR	211LH	211LR	211VH	211VR	95	(43)
317MH	317MR	314LH	314LR	313VH	313VR	124	(56)
320MH	320MR	316LH	316LR	316VH	316VR	130	(59)
422MH	422MR	418LH	418LR	418VH	418VR	145	(66)
427MH	427MR	421LH	421LR	421VH	421VR	163	(74)
534MH	534MR	526LH	526LR	524VH	524VR	198	(90)
640MH	640MR	631LH	631LR	627VH	627VR	233	(106)

# RECOMMENDED THERMAL EXPANSION VALVE SELECTIONS TLP - LOW PROFILE EVAPORATORS

## Medium Temperature Models

Model TLP	R404A R507		R407A R407C R448A R449A	
	SPORLAN	SOLENOID VALVES	SPORLAN	SOLENOID VALVES
104MA-S1D	EBQSE-AA-C	3	EBQVE-AAA-C	3
106MA-S1D	EBQSE-A-C	3	EBQVE-AA-C	3
107MA-S1D	EBQSE-A-C	3	EBQVE-AA-C	3
209MA-S1D	EBQSE-A-C	3	EBQVE-A-C	3
211MA-S1D	EBQSE-B-C	3	EBQVE-A-C	3
214MA-S1D	EBQSE-B-C	5	EBQVE-A-C	3
317MA-S1D	EBQSE-B-C	5	EBQVE-A-C	3
320MA-S1D	EBQSE-B-C	5	EBQVE-B-C	5
422MA-S1D	EBQSE-C-C	6	EBQVE-B-C	5
427MA-S1D	EBQSE-C-C	6	EBQVE-B-C	5
534MA-S1D	EBSSE-6-C	6	EBQVE-C-C	6
640MA-S1D	EBSSE-6-C	6	EBQVE-C-C	6

Above selections based on: 1) 100°F ( 38°C ) vapor free liquid entering expansion valve,  
2) 110°F ( 43°C ) condensing temperature, 3) 9-12°F ( 4.4-6.7C ) evaporator TD

## Low Temperature 6FPI Models

Model TLP	R404A R507		R407A R448A R449A	
	SPORLAN	SOLENOID VALVES	SPORLAN	SOLENOID VALVES
104LE-S2D	EBQSE-AA-ZP	3	EBQVE-AA-ZP	3
105LE-S2D	EBQSE-A-ZP	3	EBQVE-AA-ZP	3
106LE-S2D	EBQSE-A-ZP	3	EBQVE-AA-ZP	3
207LE-S2D	EBQSE-A-ZP	3	EBQVE-A-ZP	3
209LE-S2D	EBQSE-A-ZP	3	EBQVE-A-ZP	3
211LE-S2D	EBQSE-B-ZP	3	EBQVE-A-ZP	3
314LE-S2D	EBQSE-B-ZP	5	EBQVE-B-ZP	3
316LE-S2D	EBQSE-C-ZP	5	EBQVE-B-ZP	5
418LE-S2D	EBQSE-C-ZP	5	EBQVE-B-ZP	5
421LE-S2D	EBQSE-C-ZP	6	EBQVE-C-ZP	5
526LE-S2D	EBSSE-6-ZP	6	EBQVE-C-ZP	5
631LE-S2D	EBSSE-6-ZP	6	EBQVE-C-ZP	6

Above selections based on: 1) 100°F ( 38°C ) vapor free liquid entering expansion valve,  
2) 110°F ( 43°C ) condensing temperature, 3) 9-12°F ( 4.4-6.7C ) evaporator TD

## Low Temperature 4FPI Models

Model TLP	R404A R507		R407A R448A R449A	
	SPORLAN	SOLENOID VALVES	SPORLAN	SOLENOID VALVES
103VE-S2D	EBQSE-AA-ZP	3	EBQVE-AA-ZP	3
104VE-S2D	EBQSE-AA-ZP	3	EBQVE-AA-ZP	3
106VE-S2D	EBQSE-A-ZP	3	EBQVE-AA-ZP	3
207VE-S2D	EBQSE-A-ZP	3	EBQVE-A-ZP	3
208VE-S2D	EBQSE-A-ZP	3	EBQVE-A-ZP	3
211VE-S2D	EBQSE-A-ZP	3	EBQVE-A-ZP	3
313VE-S2D	EBQSE-B-ZP	5	EBQVE-B-ZP	3
316VE-S2D	EBQSE-B-ZP	5	EBQVE-B-ZP	3
418VE-S2D	EBQSE-C-ZP	5	EBQVE-B-ZP	3
421VE-S2D	EBQSE-C-ZP	6	EBQVE-B-ZP	5
524VE-S2D	EBSSE-6-ZP	6	EBQVE-C-ZP	5
627VE-S2D	EBSSE-6-ZP	6	EBQVE-C-ZP	5

Above selections based on: 1) 100°F ( 38°C ) vapor free liquid entering expansion valve,  
2) 110°F ( 43°C ) condensing temperature, 3) 9-12°F ( 4.4-6.7C ) evaporator TD



# FACTORY INSTALLED EXPANSION VALVE SELECTIONS TLP - LOW PROFILE EVAPORATORS

## Models with ESP+

### Medium Temperature Air Or Electric Defrost All Refrigerants

MODEL TLP	FACTORY INSTALLED NOZZLE	FACTORY INSTALLED EXPANSION VALVE	FACTORY INSTALLED LIQUID LINE SOLENOID VALVE
104M***	N/A	E2V9	E3
106M***	L1/2	E2V11	E3
107M***	L1/2	E2V14	E3
209M***	L3/4	E2V14	E3
211M***	L1	E2V14	E3
214M***	L1	E2V18	E3
317M***	L1-1/2	E2V18	E5
320M***	L1-1/2	E2V24	E5
422M***	L2	E2V24	E5
427M***	L2	E2V24	E5
534M***	L2-1/2	E2V35	E6
640M***	G3	E2V35	E6

\*\*\* Insert Air or Electric Defrost type. See nomenclature for details.  
ESP+ not available on Hot Gas Defrost models

### Low Temperature Electric Defrost 6 FPI All Refrigerants

MODEL TLP	FACTORY INSTALLED NOZZLE	FACTORY INSTALLED EXPANSION VALVE	FACTORY INSTALLED LIQUID LINE SOLENOID VALVE
104LE	L1/2	E2V9	E3
105LE	L3/4	E2V9	E3
106LE	L1	E2V11	E3
207LE	L1	E2V11	E3
209LE	L1-1/2	E2V11	E3
211LE	L2	E2V14	E3
314LE	L2	E2V14	E5
316LE	L3	E2V18	E5
418LE	L3	E2V18	E5
421LE	G4	E2V24	E5
526LE	G4	E2V24	E6
631LE	G5	E2V24	E6

### Low Temperature Electric Defrost 4 FPI All Refrigerants

MODEL TLP	FACTORY INSTALLED NOZZLE	FACTORY INSTALLED E2V EXPANSION VALVE	FACTORY INSTALLED LIQUID LINE SOLENOID VALVE
103VE	L1/2	E2V9	E3
104VE	L3/4	E2V9	E3
106VE	L1	E2V9	E3
207VE	L1	E2V11	E3
208VE	L1-1/2	E2V11	E3
211VE	L2	E2V11	E3
313VE	L2	E2V14	E3
316VE	L2-1/2	E2V14	E5
418VE	J2-1/2	E2V18	E5
421VE	G3	E2V18	E5
524VE	G4	E2V24	E5
627VE	G5	E2V24	E6

Medium Temperature, 6 FPI

TEMP	FPI	# of Fans	Model TLP	Voltage	1 X EVAPORATOR		2 X EVAPORATOR	
					Defrost Kit	Fuse Package	Defrost Kit	Fuse Package
ME - MEDIUM TEMPERATURE	6	1	104ME-S2D	208-230/1/60	DFK-02	FP-004	DFK-06	FP-008
			104ME-T3D	208-230/3/60	DFK-03	FP-013	DFK-07	FP-018
			106ME-S2D	208-230/1/60	DFK-02	FP-004	DFK-06	FP-008
			106ME-T3D	208-230/3/60	DFK-03	FP-013	DFK-07	FP-018
			107ME-S2D	208-230/1/60	DFK-02	FP-004	DFK-06	FP-008
			107ME-T3D	208-230/3/60	DFK-03	FP-013	DFK-07	FP-018
		2	209ME-S2D	208-230/1/60	DFK-02	FP-004	DFK-06	FP-008
			209ME-T3D	208-230/3/60	DFK-03	FP-013	DFK-07	FP-018
			211ME-S2D	208-230/1/60	DFK-02	FP-004	DFK-06	FP-008
			211ME-T3D	208-230/3/60	DFK-03	FP-013	DFK-07	FP-018
			214ME-S2D	208-230/1/60	DFK-02	FP-004	DFK-06	FP-008
			214ME-T3D	208-230/3/60	DFK-03	FP-013	DFK-07	FP-018
		3	317ME-S2D	208-230/1/60	DFK-02	FP-004	DFK-06	FP-008
			317ME-T3D	208-230/3/60	DFK-03	FP-013	DFK-07	FP-018
			320ME-S2D	208-230/1/60	DFK-02	FP-004	DFK-06	FP-008
			320ME-T3D	208-230/3/60	DFK-03	FP-013	DFK-07	FP-018
		4	422ME-S2D	208-230/1/60	DFK-02	FP-006	DFK-06	FP-015
			422ME-T3D	208-230/3/60	DFK-03	FP-013	DFK-07	FP-018
			427ME-S2D	208-230/1/60	DFK-02	FP-006	DFK-06	FP-015
			427ME-T3D	208-230/3/60	DFK-03	FP-013	DFK-07	FP-018
		5	534ME-S2D	208-230/1/60	DFK-02	FP-007	DFK-06	FP-010
			534ME-T3D	208-230/3/60	DFK-03	FP-014	DFK-07	FP-019
		6	640ME-S2D	208-230/1/60	DFK-02	FP-020	DFK-09	FP-021
			640ME-T3D	208-230/3/60	DFK-03	FP-014	DFK-07	FP-019

Low Temperature, 6 FPI

TEMP	FPI	# of Fans	Model TLP	Voltage	1 X EVAPORATOR		2 X EVAPORATOR	
					Defrost Kit	Fuse Package	Defrost Kit	Fuse Package
LE - LOW TEMPERATURE	6	1	KLP104LE-S2D	208-230/1/60	DFK-02	FP-004	DFK-06	FP-008
			KLP104LE-T3D	208-230/3/60	DFK-03	FP-013	DFK-07	FP-018
			KLP105LE-S2D	208-230/1/60	DFK-02	FP-004	DFK-06	FP-008
			KLP105LE-T3D	208-230/3/60	DFK-03	FP-013	DFK-07	FP-018
			KLP106LE-S2D	208-230/1/60	DFK-02	FP-004	DFK-06	FP-008
			KLP106LE-T3D	208-230/3/60	DFK-03	FP-013	DFK-07	FP-018
		2	KLP207LE-S2D	208-230/1/60	DFK-02	FP-004	DFK-06	FP-008
			KLP207LE-T3D	208-230/3/60	DFK-03	FP-013	DFK-07	FP-018
			KLP209LE-S2D	208-230/1/60	DFK-02	FP-004	DFK-06	FP-008
			KLP209LE-T3D	208-230/3/60	DFK-03	FP-013	DFK-07	FP-018
			KLP211LE-S2D	208-230/1/60	DFK-02	FP-004	DFK-06	FP-008
			KLP211LE-T3D	208-230/3/60	DFK-03	FP-013	DFK-07	FP-018
		3	KLP314LE-S2D	208-230/1/60	DFK-02	FP-004	DFK-06	FP-008
			KLP314LE-T3D	208-230/3/60	DFK-03	FP-013	DFK-07	FP-018
			KLP316LE-S2D	208-230/1/60	DFK-02	FP-004	DFK-06	FP-008
			KLP316LE-T3D	208-230/3/60	DFK-03	FP-013	DFK-07	FP-018
		4	KLP418LE-S2D	208-230/1/60	DFK-02	FP-006	DFK-06	FP-015
			KLP418LE-T3D	208-230/3/60	DFK-03	FP-013	DFK-07	FP-018
			KLP421LE-S2D	208-230/1/60	DFK-02	FP-006	DFK-06	FP-015
			KLP421LE-T3D	208-230/3/60	DFK-03	FP-013	DFK-07	FP-018
		5	KLP526LE-S2D	208-230/1/60	DFK-02	FP-007	DFK-06	FP-010
			KLP526LE-T3D	208-230/3/60	DFK-03	FP-014	DFK-07	FP-019
		6	KLP631LE-S2D	208-230/1/60	DFK-02	FP-020	DFK-09	FP-021
			KLP631LE-T3D	208-230/3/60	DFK-03	FP-014	DFK-07	FP-019

Low Temperature, 4 FPI

TEMP	FPI	# of Fans	Model TLP	Voltage	1 X EVAPORATOR		2 X EVAPORATOR	
					Defrost Kit	Fuse Package	Defrost Kit	Fuse Package
VE - LOW TEMPERATURE	4	1	103VE-S2D	208-230/1/60	DFK-02	FP-004	DFK-06	FP-008
			103VE-T3D	208-230/3/60	DFK-03	FP-013	DFK-07	FP-018
			104VE-S2D	208-230/1/60	DFK-02	FP-004	DFK-06	FP-008
			104VE-T3D	208-230/3/60	DFK-03	FP-013	DFK-07	FP-018
			106VE-S2D	208-230/1/60	DFK-02	FP-004	DFK-06	FP-008
			106VE-T3D	208-230/3/60	DFK-03	FP-013	DFK-07	FP-018
		2	207VE-S2D	208-230/1/60	DFK-02	FP-004	DFK-06	FP-008
			207VE-T3D	208-230/3/60	DFK-03	FP-013	DFK-07	FP-018
			208VE-S2D	208-230/1/60	DFK-02	FP-004	DFK-06	FP-008
			208VE-T3D	208-230/3/60	DFK-03	FP-013	DFK-07	FP-018
			211VE-S2D	208-230/1/60	DFK-02	FP-004	DFK-06	FP-008
			211VE-T3D	208-230/3/60	DFK-03	FP-013	DFK-07	FP-018
		3	313VE-S2D	208-230/1/60	DFK-02	FP-004	DFK-06	FP-008
			313VE-T3D	208-230/3/60	DFK-03	FP-013	DFK-07	FP-018
			316VE-S2D	208-230/1/60	DFK-02	FP-004	DFK-06	FP-008
			316VE-T3D	208-230/3/60	DFK-03	FP-013	DFK-07	FP-018
		4	418VE-S2D	208-230/1/60	DFK-02	FP-006	DFK-06	FP-015
			418VE-T3D	208-230/3/60	DFK-03	FP-013	DFK-07	FP-018
			421VE-S2D	208-230/1/60	DFK-02	FP-006	DFK-06	FP-015
			421VE-T3D	208-230/3/60	DFK-03	FP-013	DFK-07	FP-018
		5	524VE-S2D	208-230/1/60	DFK-02	FP-007	DFK-06	FP-010
			524VE-T3D	208-230/3/60	DFK-03	FP-014	DFK-07	FP-019
		6	627VE-S2D	208-230/1/60	DFK-02	FP-020	DFK-09	FP-021
			627VE-T3D	208-230/3/60	DFK-03	FP-014	DFK-07	FP-019

**For info on matched  
Trenton condensing units,  
visit  
[www.t-rp.com/cu](http://www.t-rp.com/cu)**

**Defrost Kit &  
Fuse Package  
Online Selection Tool:  
[www.t-rp.com/dfk](http://www.t-rp.com/dfk)**

**Defrost Kits**

Number of Evaps.	Kit Part Number	Description
1	<b>DFK-01</b>	Time Clock, HtrCont - 1x 40A (3P), FB 1x 30A (1P)
1	<b>DFK-02</b>	Time Clock, HtrCont - 1x 40A (3P), FB 1x 30A (2P)
1	<b>DFK-03</b>	Time Clock, HtrCont - 1x 40A (3P), FB 1x 30A (3P)
1	<b>DFK-04</b>	Time Clock, HtrCont - 1x 40A (3P), FB 1x 60A (2P)
2	<b>DFK-05</b>	Time Clock, HtrCont - 1x 40A (3P), FB 2x 30A (1P)
2	<b>DFK-06</b>	Time Clock, HtrCont - 1x 40A (3P), FB 2x 30A (2P)
2	<b>DFK-07</b>	Time Clock, HtrCont - 1x 40A (3P), FB 2x 30A (3P)
2	<b>DFK-08</b>	Time Clock, HtrCont - 1x 50A (3P), FB 2x 60A (2P)
2	<b>DFK-09</b>	Time Clock, HtrCont - 1x 50A (3P), FB 2x 30A (2P)
1	<b>DFK-10</b>	Time Clock, HtrCont - 1x 40A (3P), FanCont - 1x 40A (3P), FB 2x 30A (2P)
1	<b>DFK-11</b>	Time Clock, HtrCont - 1x 40A (3P), FanCont - 1x 40A (3P), FB 2x 30A (3P)
2	<b>DFK-12</b>	Time Clock, HtrCont - 1x 40A (3P), FanCont - 1x 40A (3P), FB 4x 30A (2P)
2	<b>DFK-13</b>	Time Clock, HtrCont - 1x 40A (3P), FanCont - 1x 40A (3P), FB 4x 30A (3P)
1	<b>DFK-14</b>	Time Clock, HtrCont - 1x 40A (3P), FanCont - 1x 40A (3P), FB 1x 30A (2P), FB 1x 30A (3P)
1	<b>DFK-15</b>	Time Clock, HtrCont - 1x40A (3P), FanCont - 1x 40A (3P), FB 1x 30A (2P), FB 1x 60A (2P)
1	<b>DFK-16</b>	Time Clock, HtrCont - 1x 40A (3P), FanCont - 1x 40A (3P), FB 1x 30A (2P), FB 1x 60A (3P)
1	<b>DFK-17</b>	Time Clock, HtrCont - 1x 40A (3P), FanCont - 1x 40A (3P), FB 1x 30A (3P), FB 1x 60A (3P)
2	<b>DFK-18</b>	Time Clock, HtrCont - 1x 40A (3P), FanCont - 1x 40A (3P), FB 2x 30A (2P), FB 2x 30A (3P)
2	<b>DFK-19</b>	Time Clock, HtrCont - 1x 50A (3P), FanCont - 1x 40A (3P), FB 4x 30A (2P)
2	<b>DFK-20</b>	Time Clock, HtrCont - 1x 50A (3P), FanCont - 1x 40A (3P), FB 4x 30A (3P)
1	<b>DFK-21</b>	Time Clock, HtrCont - 1x 50A (3P), FanCont - 1x 40A (3P), FB 1x 30A (2P), FB 1x 60A (2P)
1	<b>DFK-22</b>	Time Clock, HtrCont - 1x 50A (3P), FanCont - 1x 40A (3P), FB 1x 30A (3P), FB 1x 60A (3P)
2	<b>DFK-23</b>	Time Clock, HtrCont - 1x 50A (3P), FanCont - 1x 40A (3P), FB 2x 30A (2P), FB 2x 30A (3P)
2	<b>DFK-24</b>	Time Clock, HtrCont - 1x 50A (3P), FanCont - 1x 40A (3P), FB 2x 30A (3P), FB 2x 60A (3P)
1	<b>DFK-25</b>	Time Clock, HtrCont - 2x 40A (3P), FanCont - 1x 40A (3P), FB 1x 30A (2P), FB 2x 60A (2P)
1	<b>DFK-26</b>	Time Clock, HtrCont - 2x 40A (3P), FanCont - 1x 40A (3P), FB 1x 30A (3P), FB 2x 60A (3P)
2	<b>DFK-27</b>	Time Clock, HtrCont - 2x 40A (3P), FanCont - 1x 40A (3P), FB 2x 30A (2P), FB 2x 60A (2P)
2	<b>DFK-28</b>	Time Clock, HtrCont - 2x 40A (3P), FanCont - 1x 40A (3P), FB 2x 30A (2P), FB 2x 60A (3P)
2	<b>DFK-29</b>	Time Clock, HtrCont - 2x 40A (3P), FanCont - 1x 40A (3P), FB 2x 30A (3P), FB 2x 60A (3P)
2	<b>DFK-30</b>	Time Clock, HtrCont - 2x 40A (3P), FanCont - 1x 50A (3P), FB 2x 30A (2P), FB 2x 60A (3P)
1	<b>DFK-31</b>	Time Clock, HtrCont - 2x 50A (3P), FanCont - 1x 40A (3P), FB 1x 30A (3P), FB 2x 60A (3P)
2	<b>DFK-32</b>	Time Clock, HtrCont - 2x 50A (3P), FanCont - 1x 40A (3P), FB 2x 30A (2P), FB 2x 60A (2P)
2	<b>DFK-33</b>	Time Clock, HtrCont - 2x 50A (3P), FanCont - 1x 40A (3P), FB 2x 30A (3P), FB 2x 60A (3P)
2	<b>DFK-34</b>	Time Clock, HtrCont - 4x 40A (3P), FanCont - 1x 40A (3P), FB 2x 30A (2P), FB 4x 60A (2P)
2	<b>DFK-35</b>	Time Clock, HtrCont - 4x 40A (3P), FanCont - 1x 40A (3P), FB 2x 30A (3P), FB 4x 60A (3P)
2	<b>DFK-36</b>	Time Clock, HtrCont - 4x 40A (3P), FanCont - 1x 50A (3P), FB 2x 30A (2P), FB 4x 60A (2P)
2	<b>DFK-37</b>	Time Clock, HtrCont - 4x 40A (3P), FanCont - 1x 50A (3P), FB 2x 30A (3P), FB 4x 60A (3P)
2	<b>DFK-38</b>	Time Clock, HtrCont - 4x 50A (3P), FanCont - 1x 50A (3P), FB 2x 30A (3P), FB 4x 60A (3P)
1	<b>DFK-39</b>	Time Clock, HtrCont1 - 1x 40A (3P), HtrCont2 - 2x 50A (3P), FanCont - 1x 40A (3P), FB 4x 60A (3P)

NOTE: HtrCont = Heater Contactor, FanCont = Fan Contactor, FB = Fuse Block, (1P), (2P), (3P) = Number of Poles

**Fuse Packages**

Package Part Number	Description
FP-001	FUSES (1) 15AMP
FP-002	FUSES (1) 20AMP
FP-003	FUSES (1) 25AMP
FP-004	FUSES (2) 15AMP
FP-006	FUSES (2) 20AMP
FP-007	FUSES (2) 25AMP
FP-008	FUSES (4) 15AMP
FP-010	FUSES (4) 25AMP
FP-012	FUSES (2) 35AMP
FP-013	FUSES (3) 15AMP
FP-014	FUSES (3) 20AMP
FP-015	FUSES (4) 20AMP
FP-016	FUSES (4) 20AMP (6) 45AMP
FP-017	FUSES (4) 35AMP
FP-018	FUSES (6) 15AMP
FP-019	FUSES (6) 20AMP
FP-020	FUSES (2) 30AMP
FP-021	FUSES (4) 30AMP
FP-022	FUSES (8) 15AMP
FP-023	FUSES (2) 25AMP (3) 50AMP
FP-024	FUSES (2) 20AMP (3) 45AMP
FP-025	FUSES (6) 20AMP (6) 60AMP
FP-026	FUSES (6) 15AMP (12) 40AMP
FP-027	FUSES (6) 15AMP (6) 40AMP
FP-028	FUSES (6) 20AMP (12) 40AMP
FP-029	FUSES (6) 15AMP (6) 50AMP
FP-030	FUSES (6) 15AMP (6) 45AMP
FP-031	FUSES (6) 15AMP (6) 35AMP
FP-032	FUSES (6) 15AMP (6) 30AMP
FP-033	FUSES (6) 25AMP (12) 50AMP
FP-034	FUSES (6) 20AMP (12) 35AMP
FP-035	FUSES (4) 25AMP (6) 50AMP
FP-036	FUSES (6) 25AMP (12) 60AMP
FP-037	FUSES (6) 20AMP (12) 60AMP
FP-038	FUSES (6) 20AMP (12) 50AMP
FP-039	FUSES (6) 20AMP (12) 45AMP
FP-040	FUSES (6) 15AMP (12) 45AMP
FP-041	FUSES (5) 15AMP
FP-042	FUSES (10) 15AMP
FP-043	FUSES (3) 25AMP (6) 60AMP
FP-044	FUSES (3) 20AMP (6) 60AMP
FP-045	FUSES (3) 20AMP (6) 50AMP
FP-046	FUSES (3) 25AMP (6) 45AMP
FP-047	FUSES (3) 15AMP (6) 45AMP
FP-048	FUSES (4) 15AMP (4) 45AMP
FP-049	FUSES (4) 15AMP (4) 40AMP
FP-050	FUSES (3) 15AMP (3) 60AMP
FP-051	FUSES (4) 20AMP (6) 50AMP
FP-052	FUSES (4) 15AMP (6) 45AMP
FP-053	FUSES (4) 15AMP (6) 30AMP

Package Part Number	Description
FP-054	FUSES (3) 15AMP (6) 35AMP
FP-055	FUSES (2) 15AMP (2) 45AMP
FP-056	FUSES (2) 15AMP (2) 40AMP
FP-057	FUSES (2) 20AMP (3) 50AMP
FP-058	FUSES (2) 15AMP (3) 45AMP
FP-059	FUSES (2) 15AMP (3) 30AMP
FP-060	FUSES (2) 15AMP (2) 35AMP
FP-061	FUSES (2) 15AMP (2) 50AMP
FP-062	FUSES (2) 15AMP (2) 60AMP
FP-063	FUSES (2) 15AMP (3) 25AMP
FP-064	FUSES (2) 15AMP (3) 35AMP
FP-065	FUSES (2) 15AMP (3) 40AMP
FP-066	FUSES (2) 15AMP (3) 20AMP
FP-067	FUSES (4) 15AMP (4) 35AMP
FP-068	FUSES (4) 15AMP (4) 50AMP
FP-069	FUSES (4) 15AMP (4) 60AMP
FP-070	FUSES (4) 15AMP (6) 25AMP
FP-071	FUSES (4) 15AMP (6) 35AMP
FP-072	FUSES (4) 15AMP (6) 40AMP
FP-073	FUSES (4) 15AMP (6) 20AMP
FP-074	FUSES (3) 20AMP (3) 60AMP
FP-075	FUSES (3) 20AMP (6) 35AMP
FP-076	FUSES (3) 25AMP (6) 50AMP
FP-077	FUSES (3) 35AMP (9) 45AMP
FP-078	FUSES (3) 15AMP (3) 35AMP
FP-079	FUSES (3) 15AMP (3) 45AMP
FP-080	FUSES (3) 15AMP (3) 50AMP
FP-081	FUSES (3) 20AMP (6) 40AMP
FP-082	FUSES (3) 15AMP (3) 40AMP
FP-083	FUSES (3) 15AMP (6) 40AMP
FP-084	FUSES (6) 15AMP (6) 60AMP
FP-085	FUSES (6) 15AMP (12) 35AMP
FP-086	FUSES (3) 35AMP (3) 45AMP (6) 60AMP
FP-087	FUSES (4) 20AMP (4) 40AMP (4) 50AMP
FP-088	FUSES (4) 15AMP (4) 35AMP (4) 40AMP
FP-089	FUSES (2) 20AMP (2) 40AMP (2) 50AMP
FP-090	FUSES (2) 15AMP (2) 35AMP (2) 40AMP
FP-091	FUSES (2) 20AMP (2) 35AMP (2) 40AMP
FP-092	FUSES (2) 25AMP (2) 40AMP (2) 50AMP
FP-093	FUSES (4) 20AMP (4) 35AMP (4) 40AMP
FP-094	FUSES (6) 15AMP (6) 25AMP
FP-095	FUSES (3) 15AMP (3) 25AMP
FP-096	FUSES (3) 15AMP (3) 30AMP
FP-097	FUSES (4) 15AMP (4) 30AMP
FP-098	FUSES (4) 15AMP (4) 25AMP
FP-099	FUSES (4) 15AMP (4) 20AMP
FP-100	FUSES (2) 15AMP (2) 20AMP
FP-101	FUSES (2) 15AMP (2) 25AMP
FP-102	FUSES (2) 15AMP (2) 30AMP
FP-103	FUSES (4) 25AMP (4) 40AMP (4) 50AMP

NOTE: FUSES 30AMP and Below - Class CC Type, FUSES 35AMP and Above - Class J Type

## INSTALLATION

The installation and start-up of evaporators should only be performed by qualified refrigeration mechanics. This equipment should be installed in accordance with all applicable codes, ordinances and local by-laws.

## INSPECTION

Inspect all equipment before unpacking for visible signs of damage or loss. Check shipping list against material received to ensure shipment is complete.

**IMPORTANT:** Remember, you, the consignee, must make any claim necessary against the transportation company. Shipping damage or missing parts, when discovered at the outset, will prevent later unnecessary and costly delays.

**If damage or loss during transport is evident, make claim to carrier, as this will be their responsibility, not the manufacturer's.** Should carton be damaged, but damage to equipment is not obvious, a claim should be filed for "concealed damage" with the carrier.

**IMPORTANT:** The electrical characteristics of the unit should be checked at this time to make sure they correspond to those ordered and to electrical power available at the job site.

Save all shipping papers, tags and instruction sheets for reference by installer and owner.

## APPLICATION

LP evaporators are designed for walker-in cooler and freezer applications used with wide range of refrigerants. For room temperatures above 35°F (2 °C) AND evaporating temperatures above 26°F (-3 °C), positive defrosting means (with electric or hot gas) may not be required, otherwise, electric defrost or hot gas defrost models should be used. Electric defrost models come with defrost termination and fan delay as standard to control the defrost cycle termination and fan delay, while defrost initiation means (e.g. defrost timer) is not included.

The coil must not be exposed to any abnormal atmospheric or acidic environments. This may result in corrosion to the cabinet and possible coil failure (leaks). (Consult manufacturer for optional baked on phenolic protective coatings).

## LOCATION

The unit location in the room should be selected to ensure uniform air distribution throughout the entire space to be refrigerated. Be sure that the product does not obstruct the free circulation of air. Allow a minimum of 24" clearance at each end. Do not locate evaporators over doors. Consideration should be given to the coil location in order to minimize the piping run length to the condensing unit and floor drain.

## EXPANSION VALVE (TXV) SELECTION

All units require the use of an **externally equalized** expansion valve. (A 1/4" (6 mm) O.D. equalizer line has been provided on the coil) TX valves should **not** be selected strictly by their nominal ton rating. (This rating is based at a specific pressure differential and entering liquid temperature). Since applications will differ it is suggested the following selection procedure be followed.

1. Determine actual evaporator capacity.

The nominal rating is based at 10°F T.D. (5.6°C) (Entering Air Temp. minus Evap. Temp.) Note that a higher/lower operating T.D. will increase / decrease this capacity rating by their direct ratio within a range of 8 to 12°F (4.4 to 8.3°C) T.D.

2. Determine the pressure drop across the valve by subtracting the evaporating pressure and distributor pressure drop from the high side liquid pressure.

The distributor pressure drop is typically in the range of 20 to 35 psig (1.4 to 2.4 bar) depending on the type of refrigerant and operating conditions.

3. Estimate entering liquid temperature. Temperatures lower than 100°F (38 °C) increase valve capacity ratings. Refer to valve manufacturer's specs for details.

4. Select valve from the valve manufacturer selection charts for the appropriate refrigerant, evaporating temp and pressure drop.

For best performance, the outlet of the expansion valve should be installed directly to the distributor body. If this is not possible, a straight tube up to 12 inches may be used for the connection.

Locate the expansion valve bulb on a horizontal length of suction line preferably 3 to 6 inches from the suction header. Locate the bulb at 4 or 8 clock position and insulate with a waterproof type of insulation. Clamp the bulb to ensure 100% contact of the bulb with the suction line.

Ensure appropriate nozzle has been installed in the distributor before installing valve. After following the manufacturer's installation instructions and after the room has reached the desired temperature the valve superheat should be checked. This will confirm that the evaporator is operating properly and performing to maximum efficiency. The superheat should be around 6 (3.3 °C) to 8°F (4.4 °C) for a 10 to 12°F T.D. (5.6 to 6.7 °C). Too high or low a super heat will result in unsatisfactory system performance and possible compressor problems.

## NOZZLE INSTALLATION

For common applications (Medium temp. R404A/R22/ R407A/ R448A, 8 to 12°F (4.4 to 6.7°C) T.D.; low temp. R404A/R407A/ R448A, 8 to 12°F (4.4 to 6.7°C) T.D.) the nozzle for all models has been factory installed. For other applications, refer to nozzle manufacturer's selection guide. To replace a nozzle, the nozzle retainer clip (in distributor) must be removed before inserting nozzle. Re-install clip ensuring nozzle is properly in place. A small nozzle can be drilled larger using the drill size listed in table on page 35. Ensure the hole must be accurately centered and smooth. A lathe is preferred for the drilling.

## MOUNTING

Refer to dimensional drawing for recommended mounting arrangements. Ensure adequate clearance is provided behind the coil as well as each end. The evaporators may be mounted flush with ceiling with bolts, or hanging down with rod hangers. When using rod hangers, allow adequate space between the top of the unit and the ceiling for cleaning to comply with NSF Standard 7.

**Ensure that the ceiling is level since the drain pan has been sloped for drainage during the defrost cycle.**

## DRAIN LINE

The drain line should be run from the drain connection, sloping at least 1" (25 mm) per foot and should have the size at least as large as the drain connection. A trap in a warm area outside the room must be provided to allow proper draining through the tubing. Connection should be made to proper drainage facilities that comply with local regulations.

To prevent freeze-up when the temperature of the refrigerated space is 35°F (2 °C) or lower, the drain line should be heated along its run inside the cold room. The heated drain line should be insulated. It is recommended that the heater be energized at all times. A heat input of 20 watts per foot in a 28°F (-2°C) room and 30 watts per foot for -20°F (-29°C) rooms, is satisfactory. Drain line heaters are not required for constant room temperature above 35°F (2°C).

Always trap evaporator drain line individually to prevent vapor migration.

**Ensure that the drain line has sufficient slope for proper drainage (prevention of ice build up/blockage in pan).**

## PIPING

Refrigeration grade piping must be used for all field refrigeration piping. Refrigerant line sizes are important and **may not** be the same size as the coil connections. Consult ASHRAE handbook or other similar reference book for proper line sizing. Refrigerant piping and control system should be designed to prevent possible liquid slugging (from oil or refrigerant) of the compressors on start-up after the defrost cycle. Also, it should prevent oil logging and minimize refrigerant pressure drop.

For hot gas models, refer to pages 45 - 46 for recommended piping.

## WIRING

Wire system in accordance with governing standards and local codes. Refer to data and wiring diagrams on throughout this publication for typical wiring arrangement. Electrical wiring is to be sized in accordance with minimum circuit ampacity rating (MCA). Size fuses used must not exceed the Maximum Fuse Size ratings.

For ease of identifying the proper wiring terminal, unit wiring is color coded and terminal block connections are identified.

When **fan delay thermostats** (combination fan delay and defrost termination) are installed, on start-up, the fans do not operate until the coil temperature is reduced to approximately 25°F (-4°C). It is normal for the fans to cycle a few times until the room temperature is brought down. At higher evaporating temperatures this control may not close and therefore should either be by-passed temporarily or replaced with an adjustable type. (set for a higher temperature cut-in point).

## MAINTENANCE

The unit should be periodically inspected for any dirt or ice build-up on the fin surface and cleaned if necessary with a soft whisk or brush. Also ensure coils inner (and outer) drain pans do not have any ice build-up from improper defrost operation. When replacing heater elements first remove heater retainer brackets and heater clips.

## SYSTEM CHECK

### Before Start-Up:

1. All wiring should be in accordance with local codes.
2. Refrigerant lines should be properly sized.
3. All systems preferably include a liquid line solenoid valve at immediately up stream of the expansion valve.
4. Thorough evacuation and dehydration has been performed.
5. The suction, discharge, and receiver service valves must be open.
6. The system preferably include a liquid line filter drier moisture indicator and suction filter.
7. Pour enough water into the drain pan to allow a good check on drainage and seal the trap.

### After Start-Up:

1. Check the oil level to be sure the oil charge is correct.
2. On initial start up the fans do not start until coil temperature is pulled down to approximately 25°F (-4 °C) on the coil. Also, it is normal for the fan to cycle a few times until the room temperature is pulled down.
3. If necessary, temporarily by-pass fan delay control (to run fans until room temp is lowered).
4. Be sure that the expansion valve is properly set to provide the correct amount of superheat.
5. After the box temperature is close to reaching the desired temperature, the evaporator superheat must be checked and adjustment made if necessary.

In general, evaporators running with a TD of 10°F (5.6 °C) should have a superheat reading of 6° to 8°F (3.3 °C to 4.4 °C). For evaporators with another T.D., the general rule is that the superheat should be around 60 to 80% of T.D.

6. Heavy moisture loads are usually encountered when starting the system for the first time. This may cause a rapid build-up of frost on the evaporator. During the initial pull down, we suggest that the frost build-up be watched and defrosted manually as required.
7. Observe that the system goes through at least one complete DEFROST CYCLE.



Visit  
**[www.t-rp.com/esp](http://www.t-rp.com/esp)**  
 for Quick Start Guide, Operation Manual, etc

## Standard Configurations - Refer to Nomenclature for details

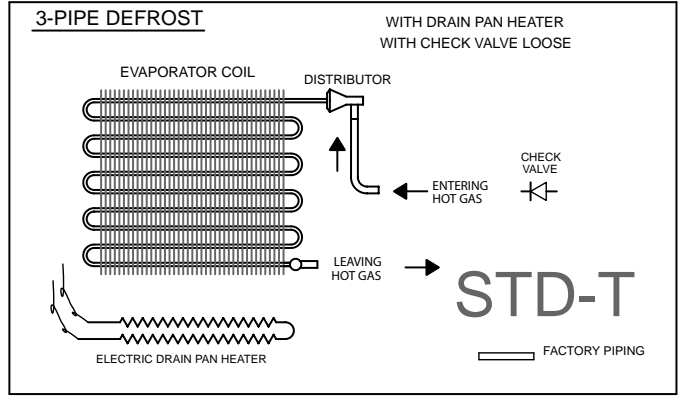
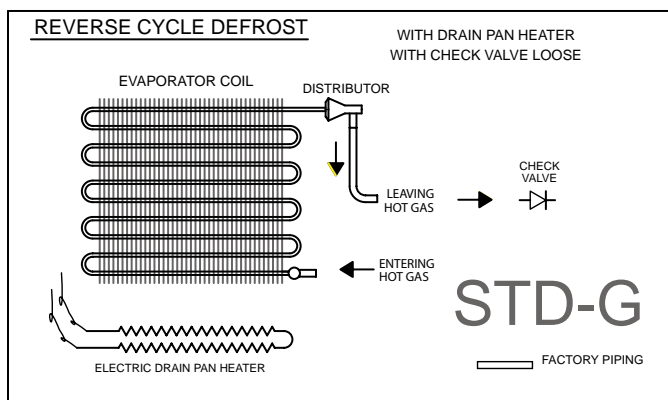
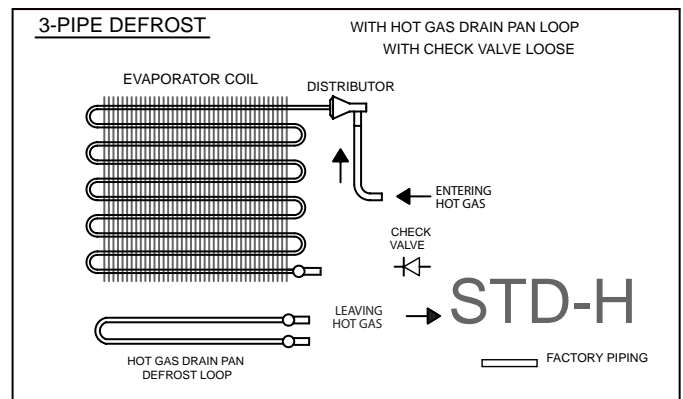
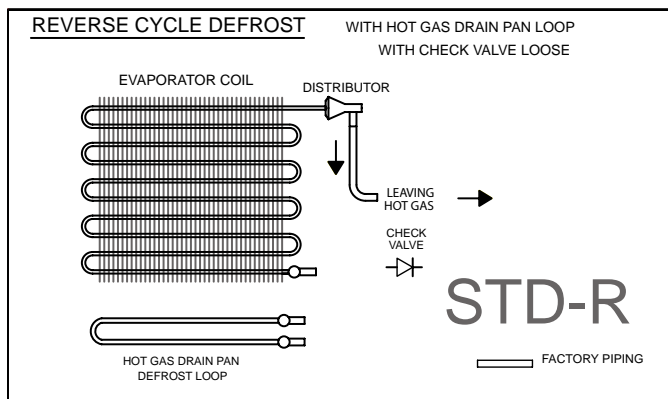
Standard Offering: All Models

Check Valve is included with the coil shipped loose as it is a must have component for system operation.

## Check Valve &amp; TXV - See next page (OPT 1)

When a TXV is ordered with a HG defrost coil: Its only option will be **Factory Installed**. The bypass check valve will be **factory installed** as well as part of the same option.

- **Reverse Cycle Pan Heater (G Models)** when ordered with TXV & Check Valve:
  - o TXV, Check Valve and bypass Tee are factory installed
- **Reverse Cycle Pan Loop (R Models)** when ordered with TXV & Check Valve:
  - o TXV, Check Valve and bypass Tee are factory installed
- **3-Pipe Pan Heater (T Models)** when ordered with TXV & Check Valve:
  - o TXV and Check Valve are factory installed
- **3-Pipe Pan Loop (H Models)** when ordered with TXV & Check Valve:
  - o TXV and Check Valve are factory installed



Optional Configurations - Refer to Nomenclature for details

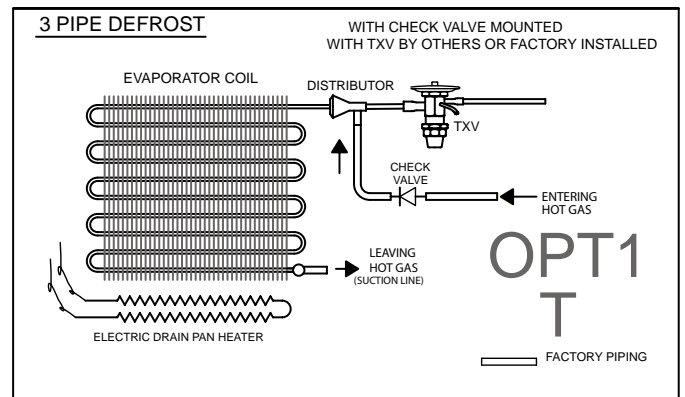
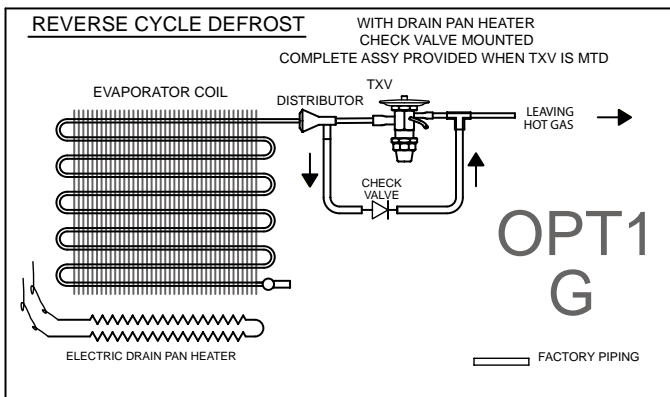
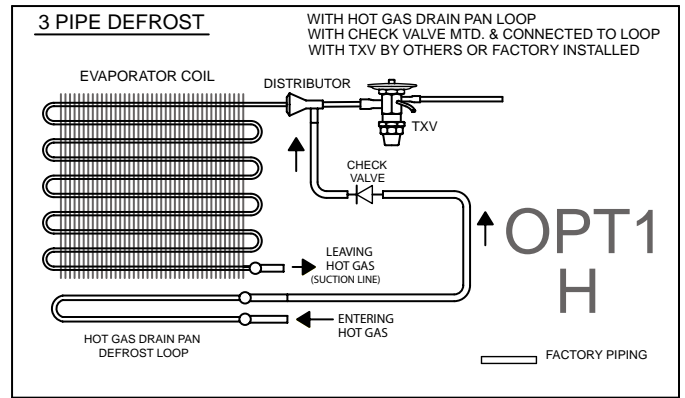
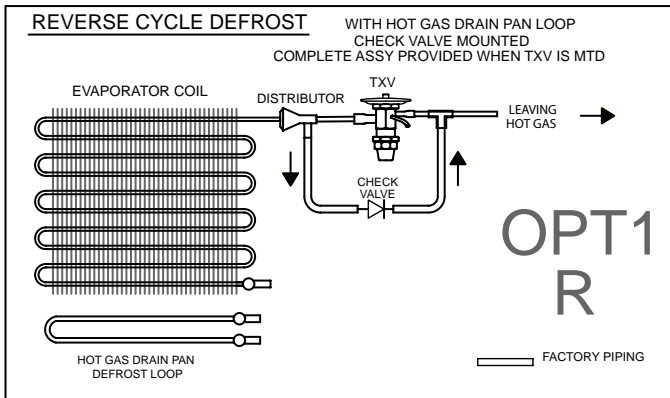

Drain pan Loop Kit - See below (OPT 2)

Drain pan loop kit is an assembly that is fully assembled and shipped loose for field installation outside the cabinet. Two check valves are included, depending on the model size, one or both are factory installed.

- **Reverse Cycle Pan Loop (R Models)** when ordered with TXV & Check Valve:
  - o Suction line piping shipped as a pre-piped assembly for field installation

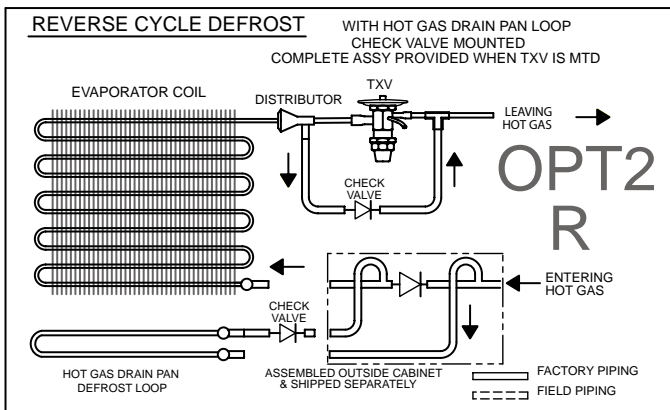

Solenoid Valve

Solenoid valves are available as a shipped loose item due to limited space inside the cabinet

**PROJECT INFORMATION****TLP - LOW PROFILE EVAPORATORS**

System	
Model Number	Date of Start-Up
Serial Number	Service Contractor
Refrigerant	Phone
Electrical Supply	E-mail

  
**PRODUCT SUPPORT**

*web: [www.t-rp.com/tlp](http://www.t-rp.com/tlp)  
email: [evaps@t-rp.com](mailto:evaps@t-rp.com)  
call: 1-844-893-3222 x520*

  
**TROUBLESHOOTING**

*email: [troubleshooting@t-rp.com](mailto:troubleshooting@t-rp.com)  
call: 1-844-893-3222 x529*

  
**SERVICE PARTS**

*web: [www.t-rp.com/parts](http://www.t-rp.com/parts)  
email: [parts@t-rp.com](mailto:parts@t-rp.com)  
call: 1-844-893-3222 x520*

  
**WARRANTY**

*web: [www.t-rp.com/warranty](http://www.t-rp.com/warranty)  
email: [warranty@t-rp.com](mailto:warranty@t-rp.com)  
call: 1-844-893-3222 x507*

  
**ORDERS**

*email: [orders@t-rp.com](mailto:orders@t-rp.com)  
call: 1-844-893-3222 x501*

  
**SHIPPING**

*email: [shipping@t-rp.com](mailto:shipping@t-rp.com)  
call: 1-844-893-3222 x503*

**HOW CAN WE HELP YOU?**  
visit [www.t-rp.com/contact](http://www.t-rp.com/contact)

# Service Parts List Label To Be Attached *HERE*



Trenton Refrigeration  
Brantford, ON • Longview, TX  
1-800-463-9517 info@t-rp.com www.t-rp.com

